

AMP Product Model Library Manual for AWR Microwave Office®

Library Version: V15p00
Date: November 11th 2020

Contents

- Model library release notes
- How to install the AMP Product Model Library and add it to your design project
- How to insert AMP Product LDMOS and GaN Models into your design
- How to correctly use AMP Products LDMOS and GaN Models with a Thermal Node.

Model Library Release Notes

The AMP Product Model Library version V15p00 supports the follow product releases:

AWR Design Environment (AWRDE) **Version 12 (64-bit simulations)** and later. *

All models are used with the APLAC simulators only.

- Use APLAC Simulators for all simulations.

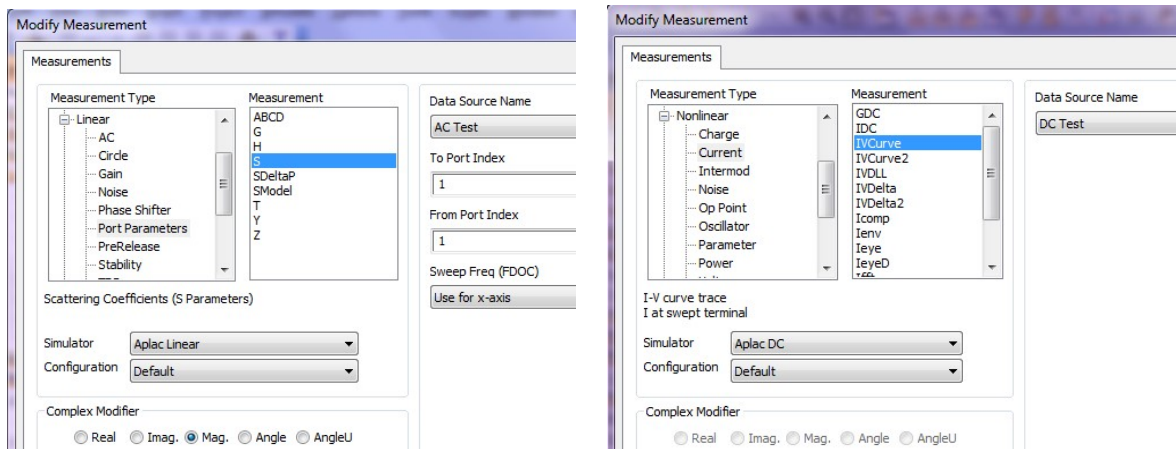

* Device model: “AMP_BLM2425M9S20” , requires AWRDE Version 14 or later.

Use APLAC Simulators for all simulations (cont.)

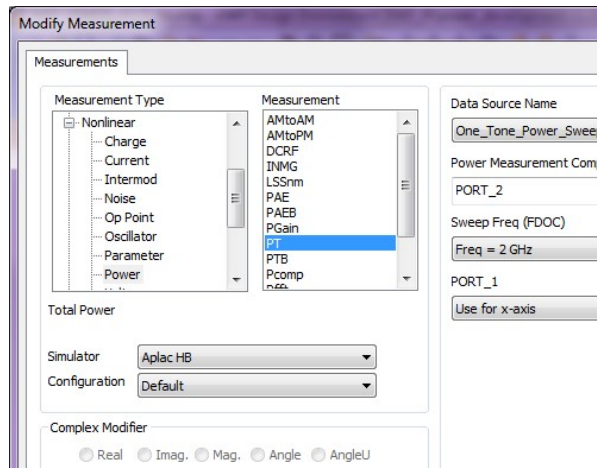

- ii. This library uses the global variable `_TEMP` as Simulation Temperature. Ensure to use Project Options => Global Units Temperature: DegC This global temperature may be assigned a value in the Global Definitions window.

Use the instance parameter “DTA” to change the specific device temperature relative to `_TEMP`.

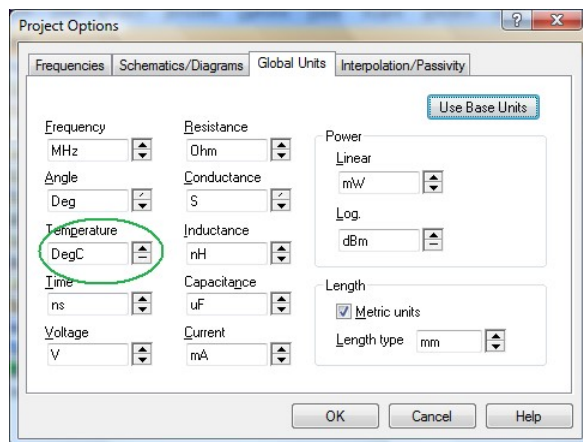

How to install the AMP Product Model Library and add it to your design project

Quick Start Guide:

- i. Unzip the file "AMP_Product_Lib_Vxxpx.zip" on your computer and place in your chosen directory.

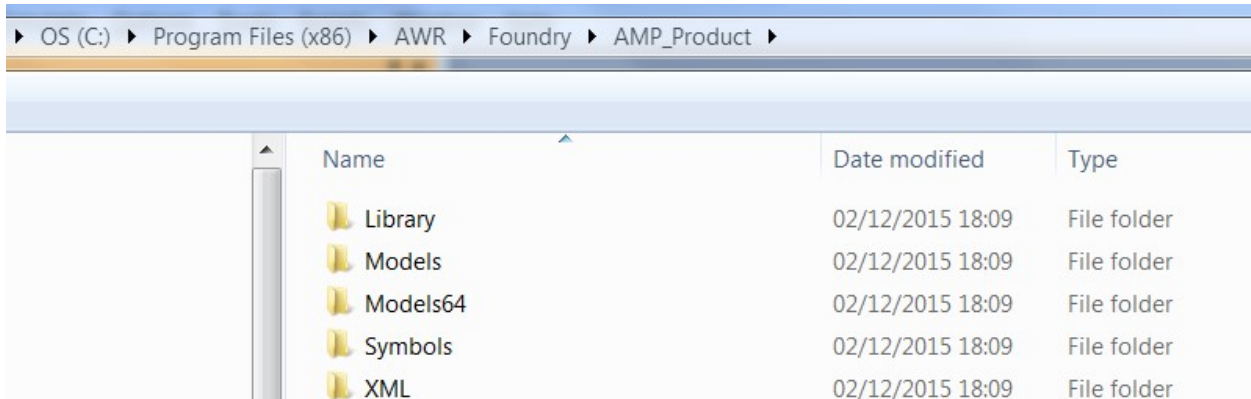

- ii. Start the MWO Application and select “New With Library”

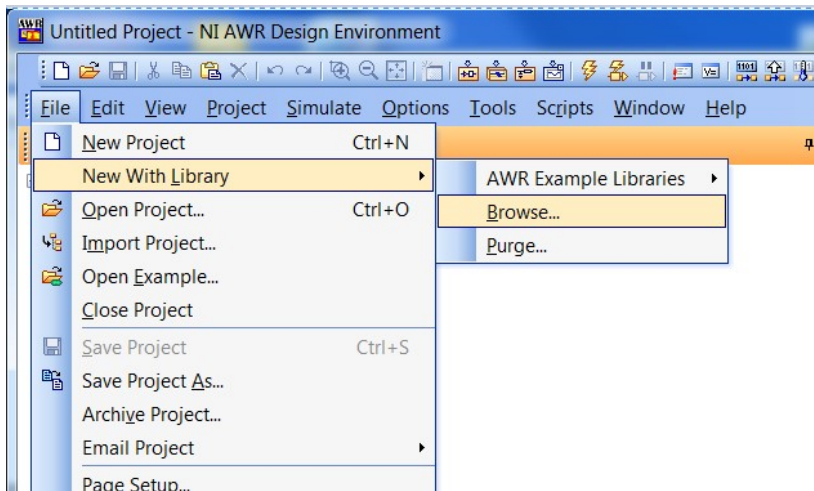

Browse to your chosen directory.

Select the file : **AMP_RFpower.ini**

How to insert AMP LDMOS and GaN Models into your design

- i. Browse to the element browser "Elements" => "Libraries". Click on the "+" sign to expand the folder "Libraries" and you should see the folder "AMP Product". Expand the folder to see either all of the parts in the complete library.
- ii. Select the transistor type you want to add to your circuit and drag and drop it to your schematic.

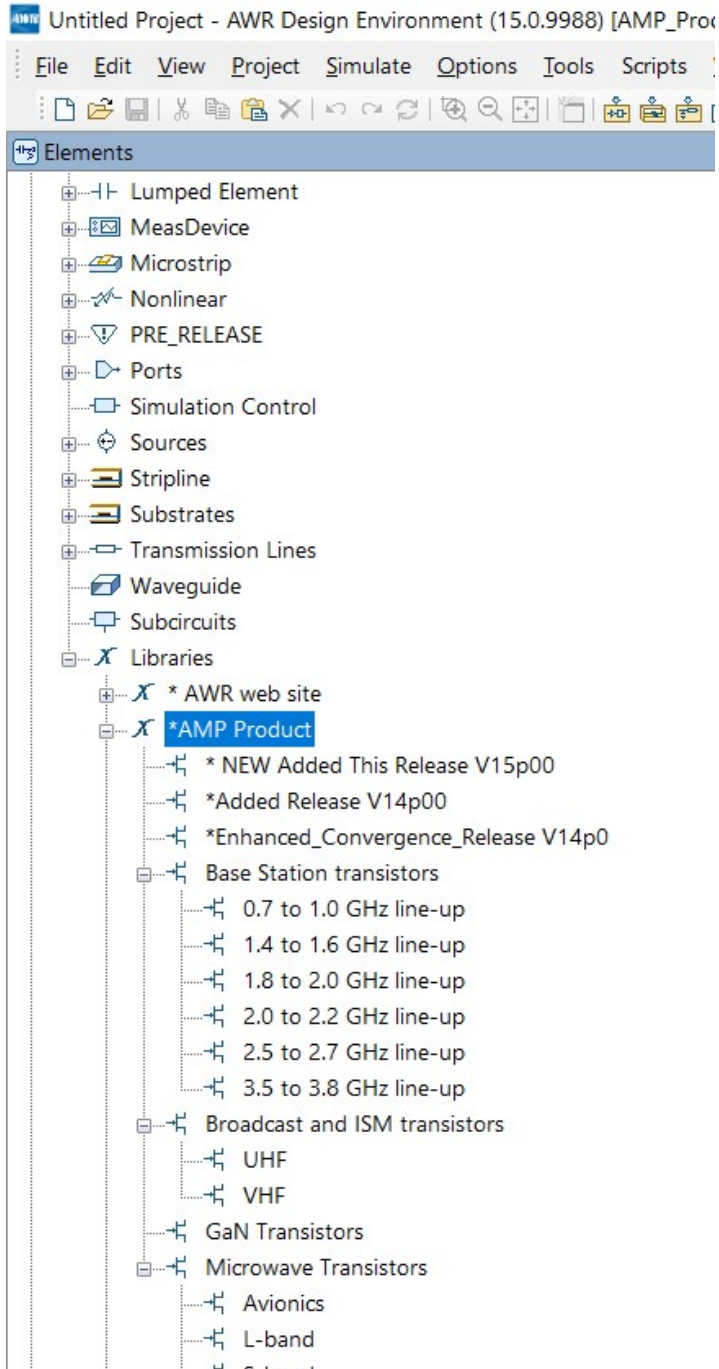

How to correctly use AMP LDMOS and GaN Models with a Thermal Node.

```
SUBCKT
ID=S1
NET="AMP_BLF7G22_130"
DTA=0
Zth_Enable=1
```

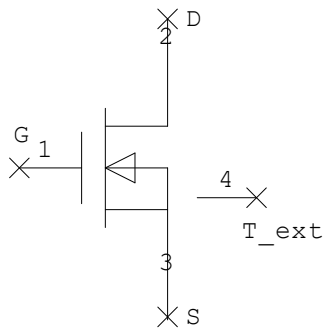

The “T_ext” node is the thermal node of the device and must be connected to the ground either directly or through a RC-parallel network which may be used to describe an additional or alternative external thermal networks.

The “Zth_Enable” parameter allows enabling or disabling the default thermal network of the device. This parameter can be used in combination with an external thermal network to reproduce the following situations:

1. Zth_Enable set to 0, T_ext node connected to ground directly: Isothermal simulations.
2. Zth_Enable set to 0, T_ext node connected to ground through a RC-parallel network: ET simulations with the external RC-parallel as thermal network.
3. Zth_Enable set to 1, T_ext node connected to ground directly: ET simulations with the default device thermal network.

2. These components might not be suitable to support time-domain simulations such as transient simulations or transient-assisted HB simulations.

3. Failing to connect the “T_ext” node to the ground either directly or through a RC-parallel network will cause the non-convergence of simulations.

4. Zth_Enable set to 1, T_ext node connected to ground through a RC-parallel network: ET simulations with the series of the external RC-parallel and the device default as thermal network.