

# BLF989 Doherty

BLF989 X 2 470-500MHz.

V1.0 — 8 July 2018

AMPLEON

Test Report

## Document information

Info	Content
Status	Company Public
Author(s)	Bob Bartola
Abstract	Measurement results of a Symmetrical Inverted Doherty design for the 470-500 MHz.band with 2 X BLF989 devices combined.

## 1 Revision History

Table 1. Report revisions

Revision No.	Date	Description	Author
1.0	20180706	Initial document	Bob Bartola

## 2 Contents

- 1 **Revision History**.....2
- 2 **Contents** .....2
- 3 **List of Figures** .....3
- 4 **List of Tables**.....4
- 5 **General Description**.....5
- 6 **Biasing**.....6
  - 6.1 Inverted Symmetrical Doherty Demo Bias Levels .....6
  - 6.2 Bench Test Set Up .....6
  - 6.3 BLF989 Symmetrical Inverted Doherty Demo Block Diagram .....7
  - 6.4 BLF989 X 2 Symmetrical Inverted Doherty Demo .....10
- 7 **Performance Indicators**.....11
- 8 **Test Object details** .....12
- 9 **Performance Details** .....13
  - 9.1 Uncorrected and Corrected Inverted Symmetrical Doherty Performance Tables .....13
  - 9.2 Performance Data (Graphs) .....16
- 10 **BLF989 Doherty PCB Layouts** .....20
- 11 **BLF989 Class AB and Doherty amplifier and Splitter/Combine BOM** .....23
- 12 **Legal Information**.....25
  - 12.1 Contact information .....25

**3 List of Figures**

Figure 1. Assembled Symmetrical Inverted Doherty DVB-T amplifier..... 5

Figure 2. BLF989 X 2 Inverted Symmetrical Doherty and Class AB Block Diagram Test Platform..... 7

Figure 3. Output Branchline Combiner (470-500 MHz.)..... 8

Figure 4. Output branchline S11, S21, S31, and S32 ..... 8

Figure 5. Branchline Phase and Phase Error from 90 degrees..... 9

Figure 6. Branchline Insertion Loss and Amplitude Error..... 9

Figure 7. Class AB Pulsed Gain and Efficiency vs. Pload drive up to P-6dB. PW=100uS. DF=10%..... 16

Figure 8. Inverted Symmetrical Doherty Pulsed Gain and Efficiency vs. Pload drive up to P-6dB. PW=100uS. DF=10%..... 16

Figure 9. Pload and Efficiency (Pulsed CW 100uS 10%) vs. Frequency @P-6dB..... 17

Figure 10. Pload and Efficiency CW vs. Frequency @ 300 Watts ..... 17

Figure 11. Efficiency vs Pload (Watts) Pulsed CW 100uS 10%) RF Drive up to P-6dB..... 18

Figure 12. CW 2'nd and 3'rd Harmonic Level driven to 550 Watts..... 18

Figure 13. Small Signal S11 and S21 in Doherty mode ..... 19

Figure 15. PCB Layout for Class AB Biasing (AR182049)..... 20

Figure 16. PCB Layout for Class C Biasing (AR182055) ..... 21

Figure 17. Input Splitter and Output Combiner..... 22

## 4 List of Tables

---

Table 1. Report revisions .....	2
Table 2. Demo Bias conditions: $V_{ds}=50V$ $I_{dq}$ (main)=1200mA. $V_{gs}$ (peak)=400mV.....	11
Table 3. Uncorrected ACPR and CW AM/PM performance at 470 Mhz. ....	13
Table 4. Corrected ACPR and CW AM/PM performance at 470 Mhz. ....	13
Table 5. Uncorrected ACPR and CW AM/PM performance at 485 Mhz. ....	14
Table 6. Corrected ACPR and CW AM/PM performance at 485 Mhz. ....	14
Table 7. Uncorrected ACPR and CW AM/PM performance at 500 Mhz. ....	15
Table 8. Corrected ACPR and CW AM/PM performance at 500 Mhz. ....	15
Table 9. Pro-TV Exciter Corrected DVB-T @ 300W Average Measurements .....	15
Table 10. BLF989 Class AB and C Amplifier portion BOM .....	23
Table 11. Input Splitter and Output Combiner BOM.....	24

## 5 General Description

This document contains measurement results of two Ampleon Gen9 BLF989 Symmetrical devices in an inverted symmetrical Doherty application circuit designed for the 470-500 MHz UHF band. Although this narrowband Doherty concept can be used to cover a narrow portion of the UHF band this application board was optimized for approximately 30 MHz bandwidth to improve efficiency, linearity, and harmonic rejection. The application board was tested with an 8MHz DVB-T signal using a Pro-TV exciter with bias levels of  $V_{ds}=50V$ ,  $I_{dq}(\text{main})=1200mA$ . and  $V_{gs}(\text{peak})=400mV$  and an output power of 300W average and approx..2KW pulsed Pload @ P-6dB.

Figure 1. Assembled Symmetrical Inverted Doherty DVB-T amplifier

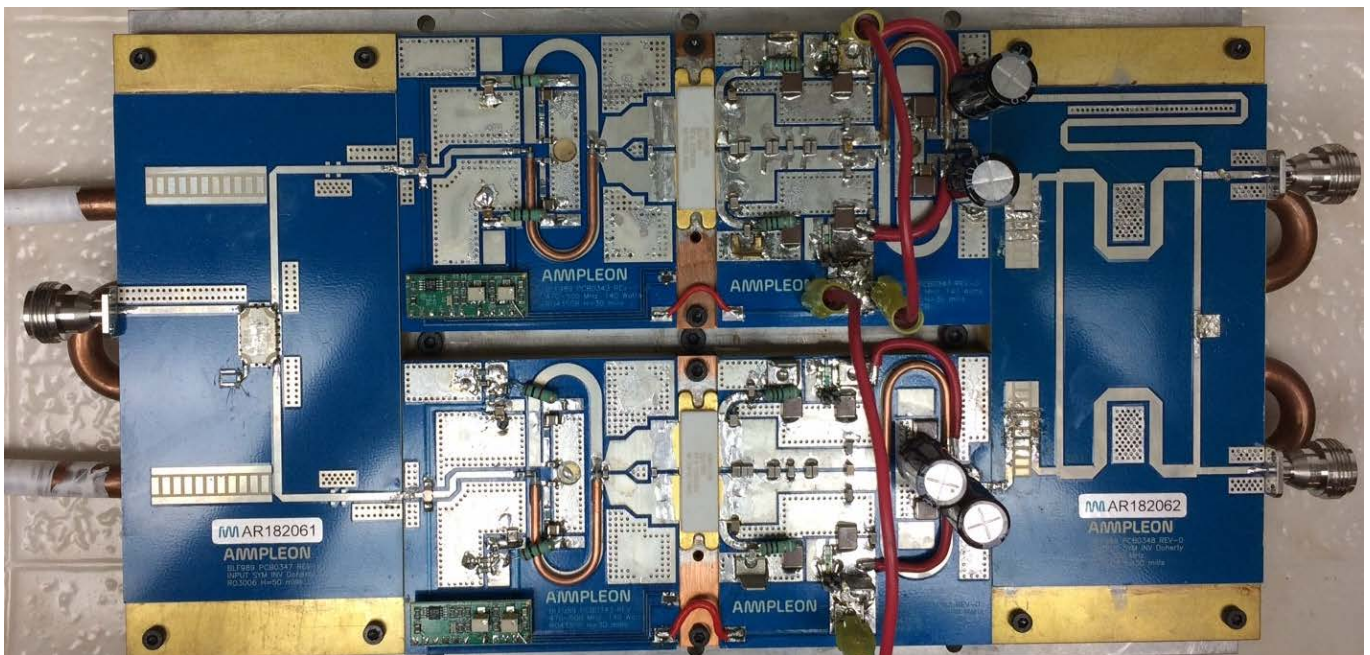

## 6 Biasing

### 6.1 Inverted Symmetrical Doherty Demo Bias Levels

The efficiencies presented are based on the currents of the drain feeds only. I.E. the biasing currents for the gate circuitry has not been included. The biasing is as follows:

- Vds(main) = 50V
- Vds(peak) = 50V
- Idq. (main)= 1200mA.
- Vgs(peak) = 400mV.

### 6.2 Bench Test Set Up

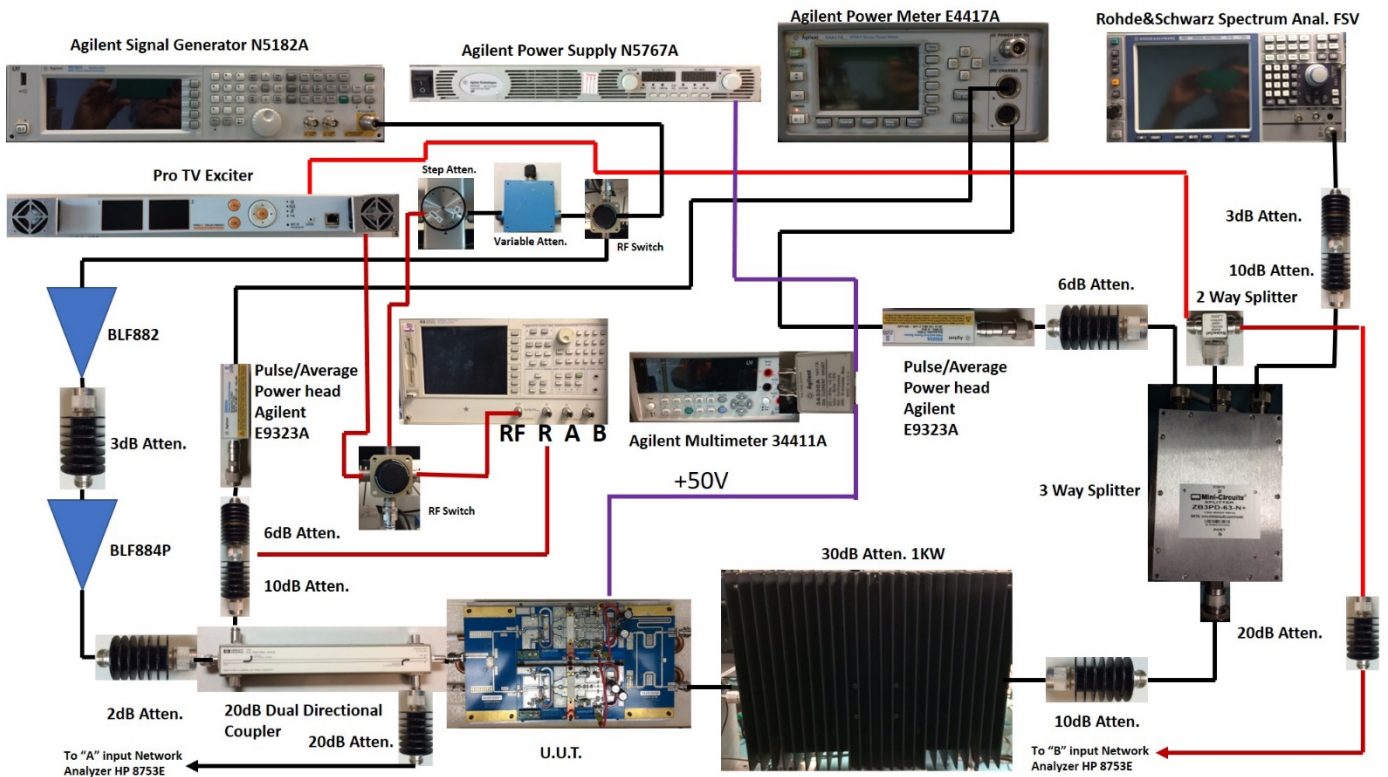

6.3 BLF989 Symmetrical Inverted Doherty Demo Block Diagram

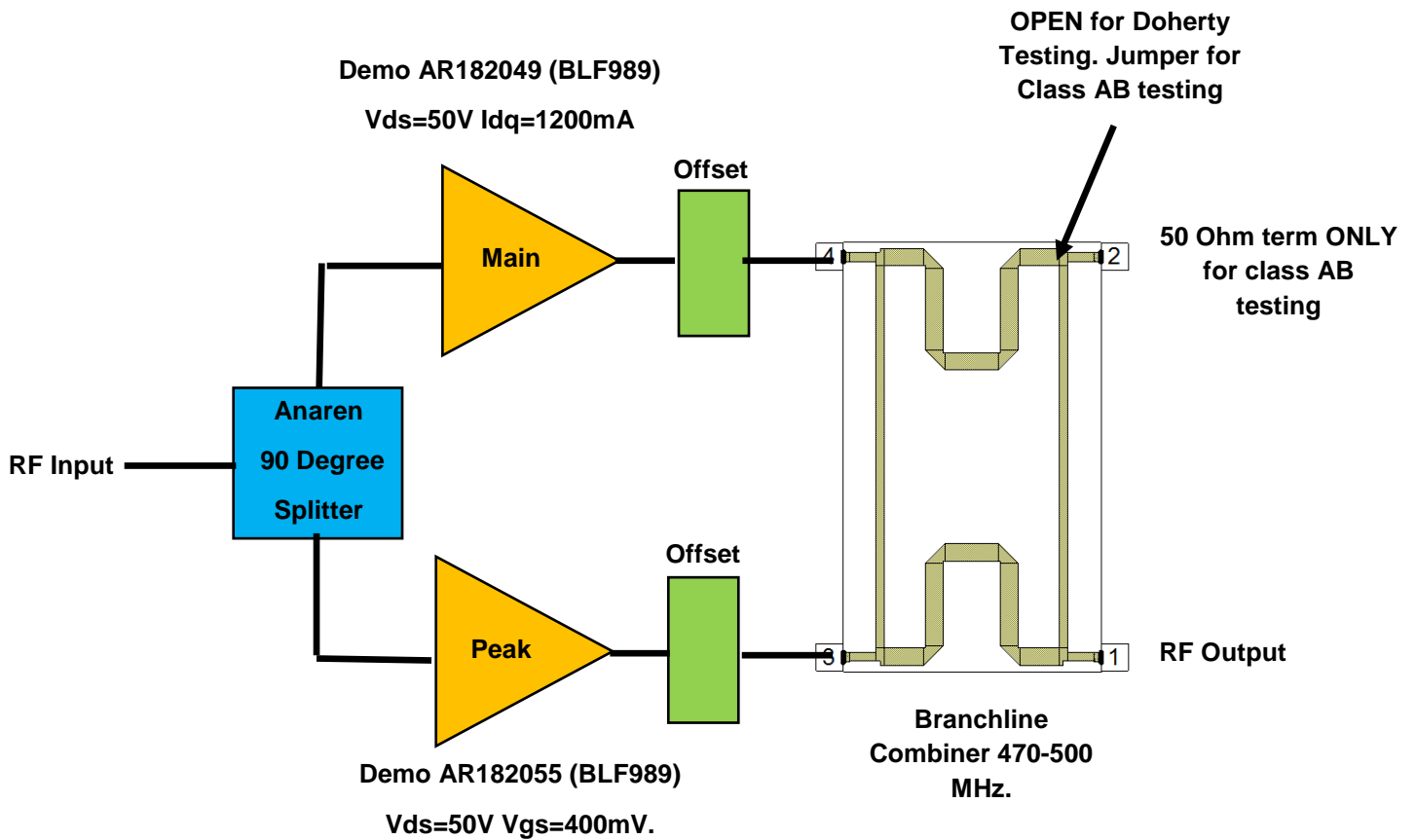

Figure 2. BLF989 X 2 Inverted Symmetrical Doherty and Class AB Block Diagram Test Platform

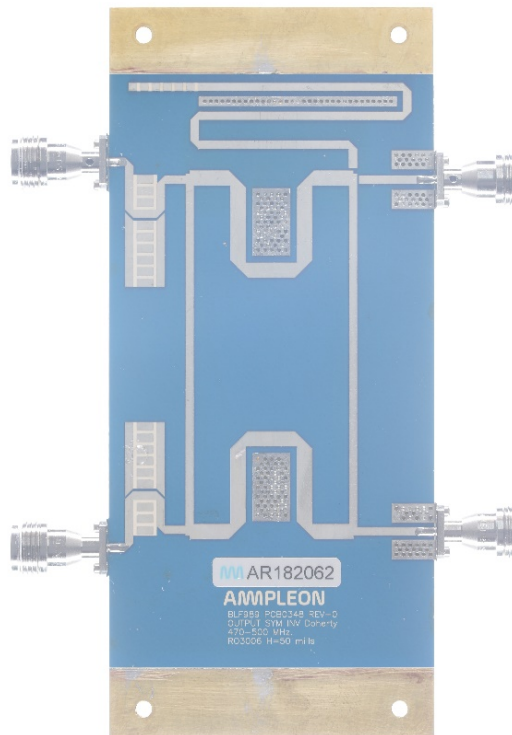

Figure 3. Output Branchline Combiner (470-500 MHz.)

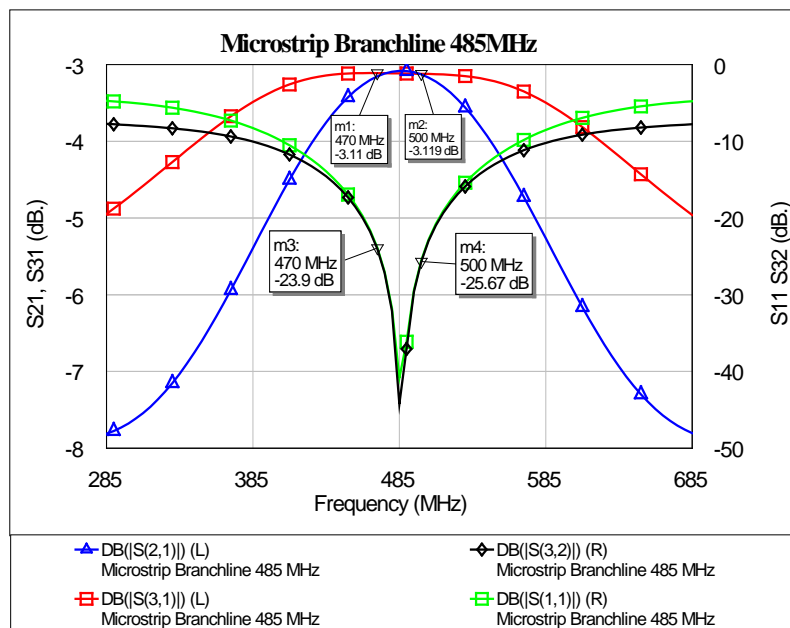

Figure 4. Output branchline S11, S21, S31, and S32



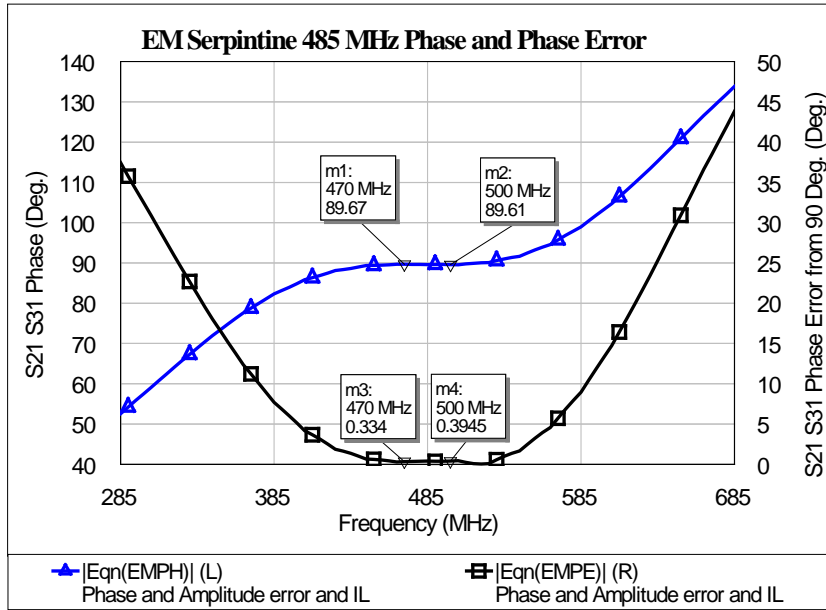

Figure 5. Branchline Phase and Phase Error from 90 degrees

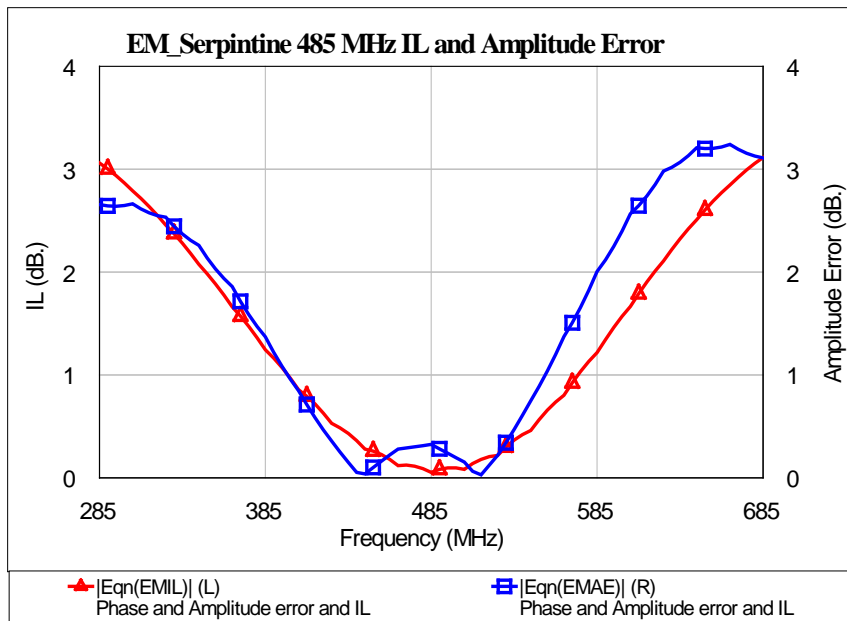
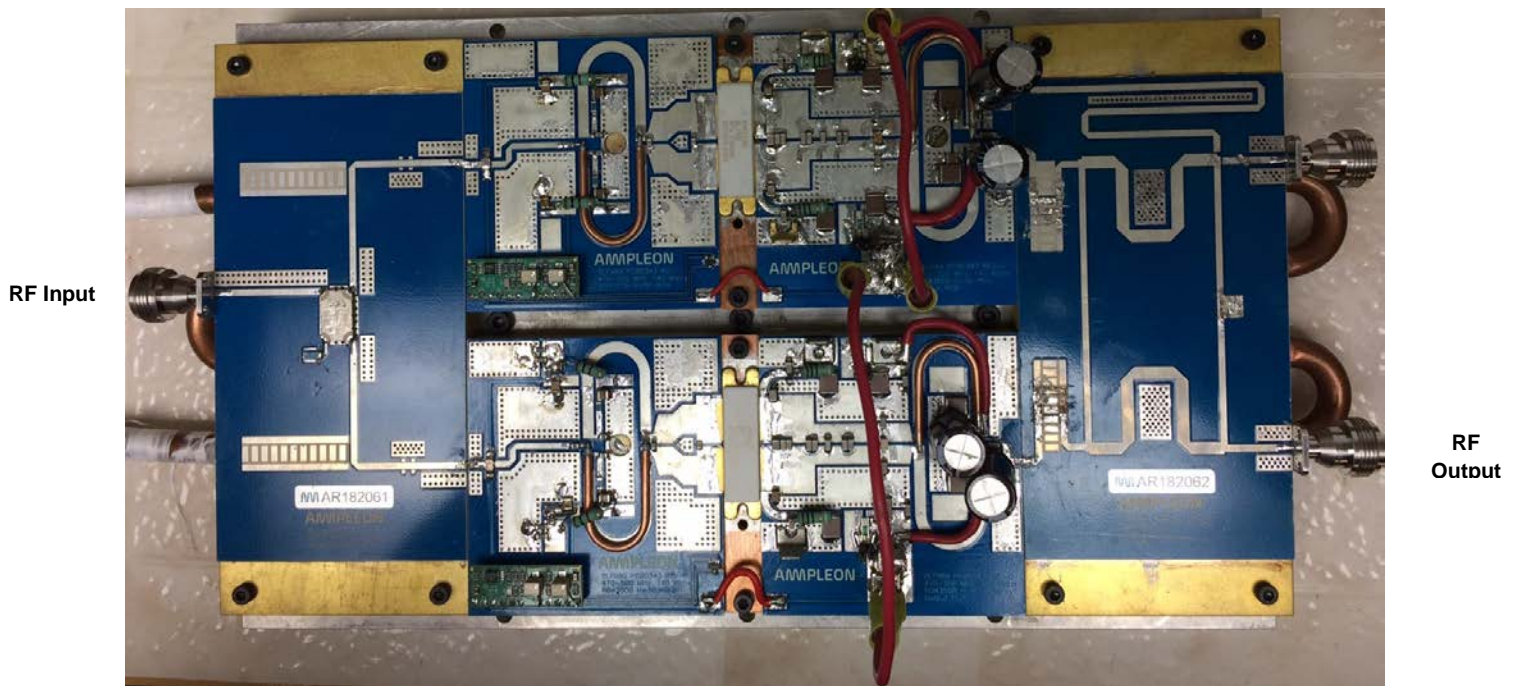

Figure 6. Branchline Insertion Loss and Amplitude Error

## 6.4 BLF989 X 2 Symmetrical Inverted Doherty Demo

AR182049 Main Amplifier



AR182055 Peak Amplifier

## 7 Performance Indicators

Table 2. Demo Bias conditions:  $V_{ds}=50V$   $I_{dq}$ . (main)=1200mA.  $V_{gs}$  (peak)=400mV.

Parameter	Condition	Unit	Demo "as-is"
Vds	470-500 MHz	V	50
Small Signal S11	470-500 MHz Small signal	RTN-L dB.	>25
Small Signal S21	470-500 MHz Small signal	Gain dB.	>16
AM-PM	Max @ 300W CW	Deg.	< 5
Corrected Shoulder Attenuation	280W Average	dBc.	-37 max.
CW Efficiency	300W Pload	%	>49
DVB-T Efficiency	300W Ave. Pload	%	>50
Gain @ 300W	CW 470-500 MHz.	dB.	>18.5

## 8 Test Object details

---

Transistor (Main amplifier) type: BLF989

Transistor (Peak amplifier) type: BLF989

Production code (Main amplifier): RFA D180389

Production code (Peak amplifier): RFA D180389

PCB Boards:

Input Splitter PCB: PCB0347 REV-0 Rogers RO3006 H=50 mills

Output Splitter PCB: PCB0348 REV-0 Rogers RO3006 H=50 mills

Main Amplifier (AR182049) PCB: PCB0343 REV-0 Rogers RO4350 H=30 mills

Peak Amplifier (AR182055) PCB: PCB0343 REV-0 Rogers RO4350 H=30 mills

**9 Performance Details**

**9.1 Uncorrected and Corrected Inverted Symmetrical Doherty Performance Tables**

DVB-T Average Pload (Watts)	Offset Frequency (MHz.)				CW AM/PM (Deg.)
	-8.6	-4.3	+4.3	+8.6	
50	-39	-33	-33	-39	+1
100	-38	-32	-32	-38	+1.5
150	-35	-29	-29	-35	+1.8
200	-33	-26	-26	-33	+2.5
250	-32	-24	-24	-32	+3.0
300	-30	-23	-23	-30	+3.6

**Table 3. Uncorrected ACPR and CW AM/PM performance at 470 Mhz.**

DVB-T Average Pload (Watts)	Offset Frequency (MHz.)				Efficiency (%)
	-8.6	-4.3	+4.3	+8.6	
200	-45	-41	-41	-45	42
250	-42	-38	-38	-42	47
300	-41	-36.5	-38	-41	50.5

**Table 4. Corrected ACPR and CW AM/PM performance at 470 Mhz.**

DVB-T Average Pload (Watts)	Offset Frequency (MHz.)				CW AM/PM (Deg.)
	-8.6	-4.3	+4.3	+8.6	
50	-38	-33	-33	-38	+1.0
100	-39	-34	-34	-39	+1.2
150	-38	-33	-33	-38	+1.4
200	-37	-31	-31	-37	+1.9
250	-35	-29	-29	-35	+2.3
300	-33	-26	-26	-33	+2.5

**Table 5. Uncorrected ACPR and CW AM/PM performance at 485 Mhz.**

DVB-T Average Pload (Watts)	Offset Frequency (MHz.)				Efficiency (%)
	-8.6	-4.3	+4.3	+8.6	
200	-45	-41	-41	-45	44
250	-44	-40	-40	-44	48
300	-42	-38	-38	-42	50.8

**Table 6. Corrected ACPR and CW AM/PM performance at 485 Mhz.**

DVB-T Average Pload (Watts)	Offset Frequency (MHz.)				CW AM/PM (Deg.)
	-8.6	-4.3	+4.3	+8.6	
50	-37	-30	-30	-37	+1.1
100	-38	-32	-32	-38	+1.4
150	-37	-32	-32	-37	+1.6
200	-36	-30	-30	-36	+3.5
250	-35	-28	-28	-35	+3.6
300	-33	-24	-24	-34	+3.9

Table 7. Uncorrected ACPR and CW AM/PM performance at 500 Mhz.

DVB-T Average Pload (Watts)	Offset Frequency (MHz.)				Efficiency (%)
	-8.6	-4.3	+4.3	+8.6	
200	-44	-40	-40	-44	44.4
250	-42	-38	-38	-42	48.5
300	-40	-36	-36	-40	51

Table 8. Corrected ACPR and CW AM/PM performance at 500 Mhz.

Frequency (MHz.)	-8.6 MHz.	-4.3 MHz.	+4.3 MHz.	+8.6 MHz.	Efficiency @300W (%)	CW AM/PM @300W (Deg.)	CW Pulsed (PW=100uS. DF=10%) Pload @ P-6dB. (WATTS)
470	-41	-36.5	-38	-41	50.5	+3.6	<b>1914</b>
485	-42	-38	-38	-42	50.8	+2.5	<b>2032</b>
500	-40	-36	-36	-40	51	+3.9	<b>1990</b>

Table 9. Pro-TV Exciter Corrected DVB-T @ 300W Average Measurements

## 9.2 Performance Data (Graphs)

Figure 7. Class AB Pulsed Gain and Efficiency vs. Pload drive up to P-6dB. PW=100uS. DF=10%

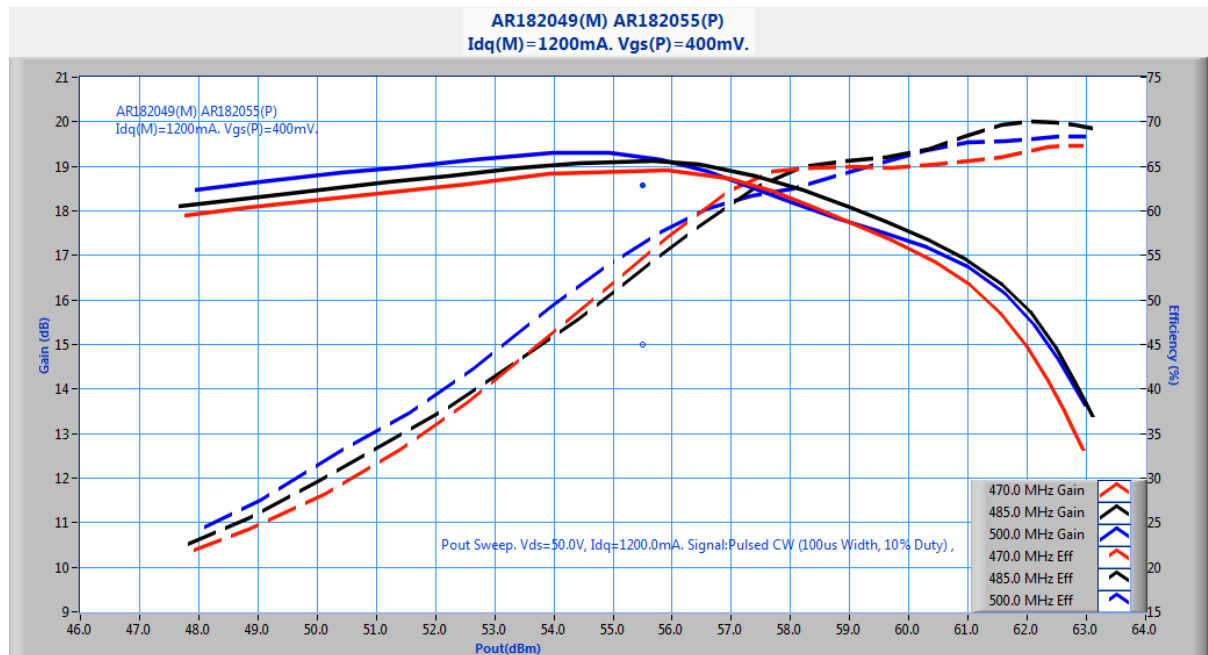
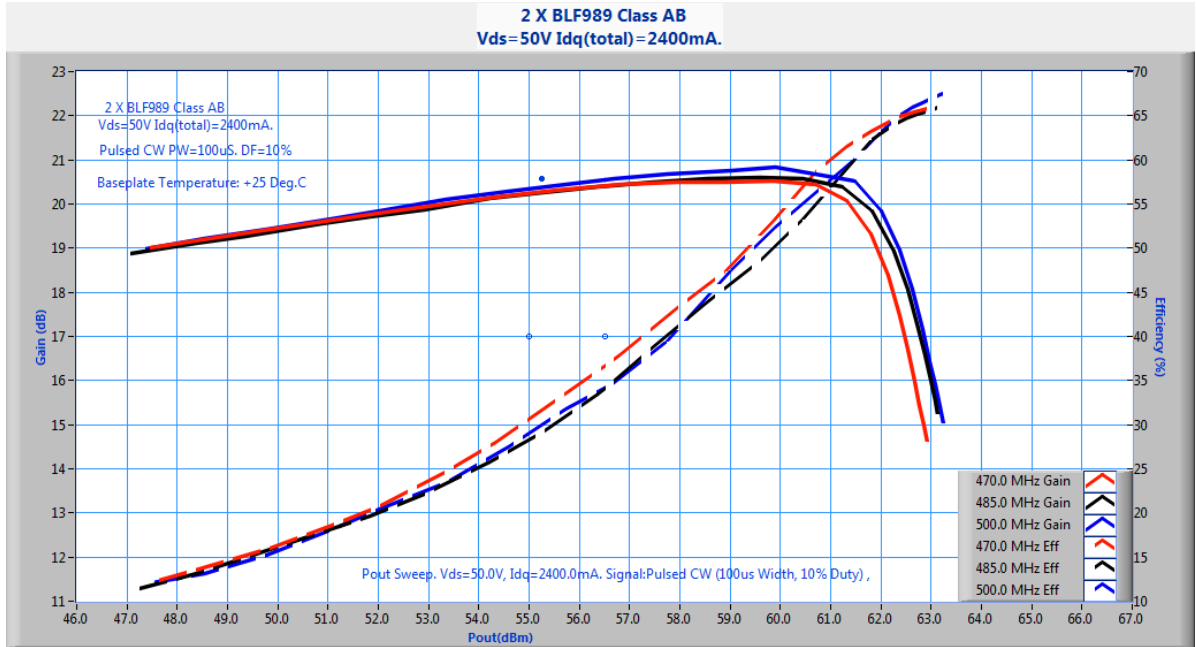

Figure 8. Inverted Symmetrical Doherty Pulsed Gain and Efficiency vs. Pload drive up to P-6dB. PW=100uS. DF=10%



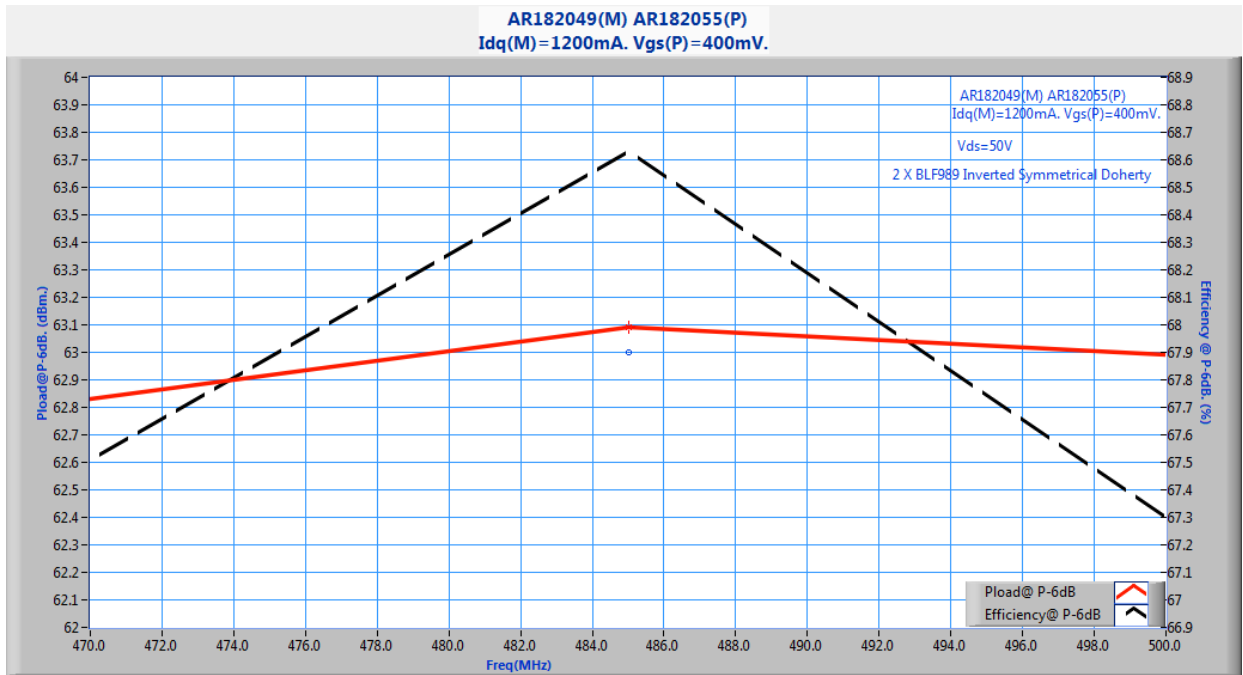

Figure 9. Pload and Efficiency (Pulsed CW 100uS 10%) vs. Frequency @ P-6dB.

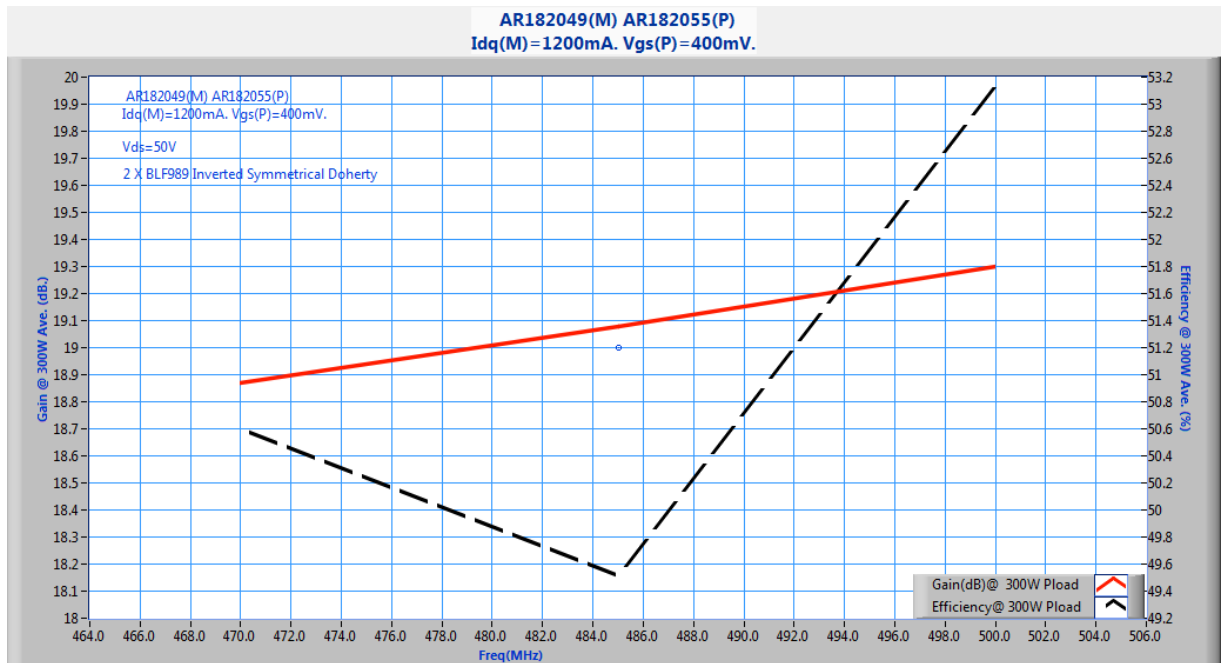

Figure 10. Pload and Efficiency CW vs. Frequency @ 300 Watts

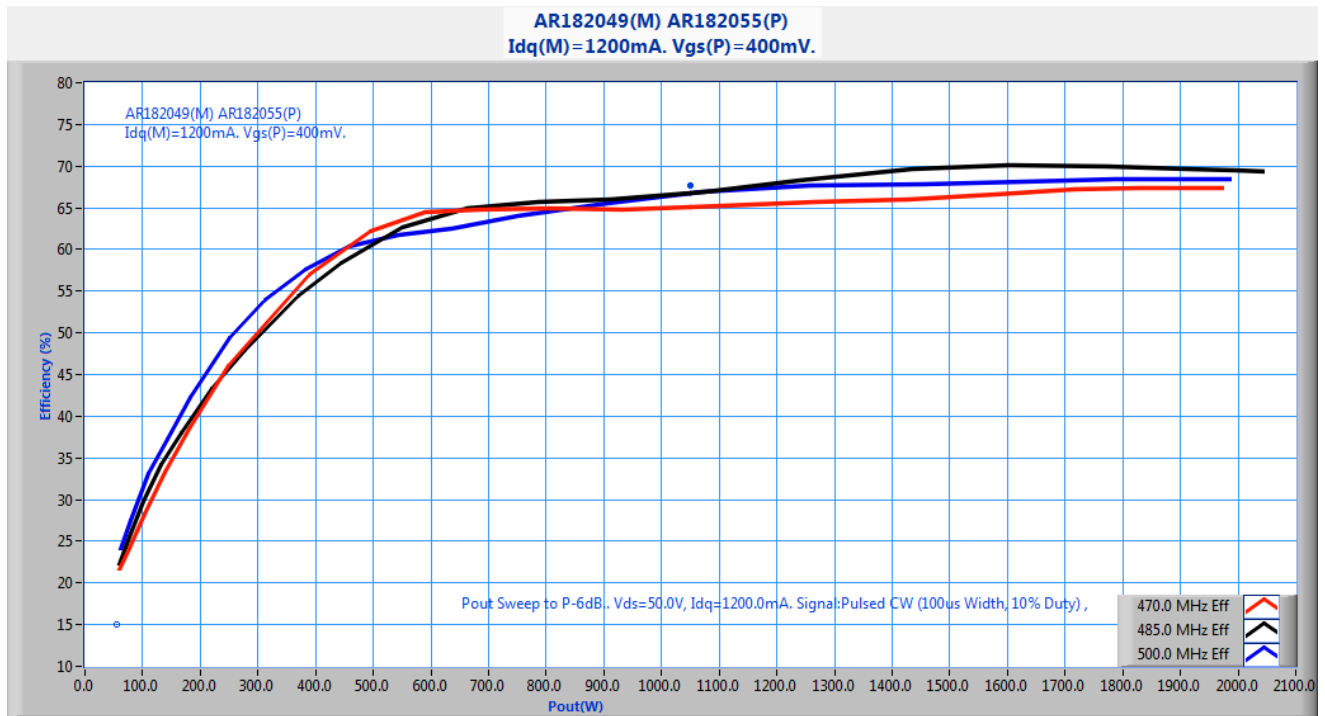

Figure 11. Efficiency vs Pload (Watts) Pulsed CW 100uS 10% RF Drive up to P-6dB.

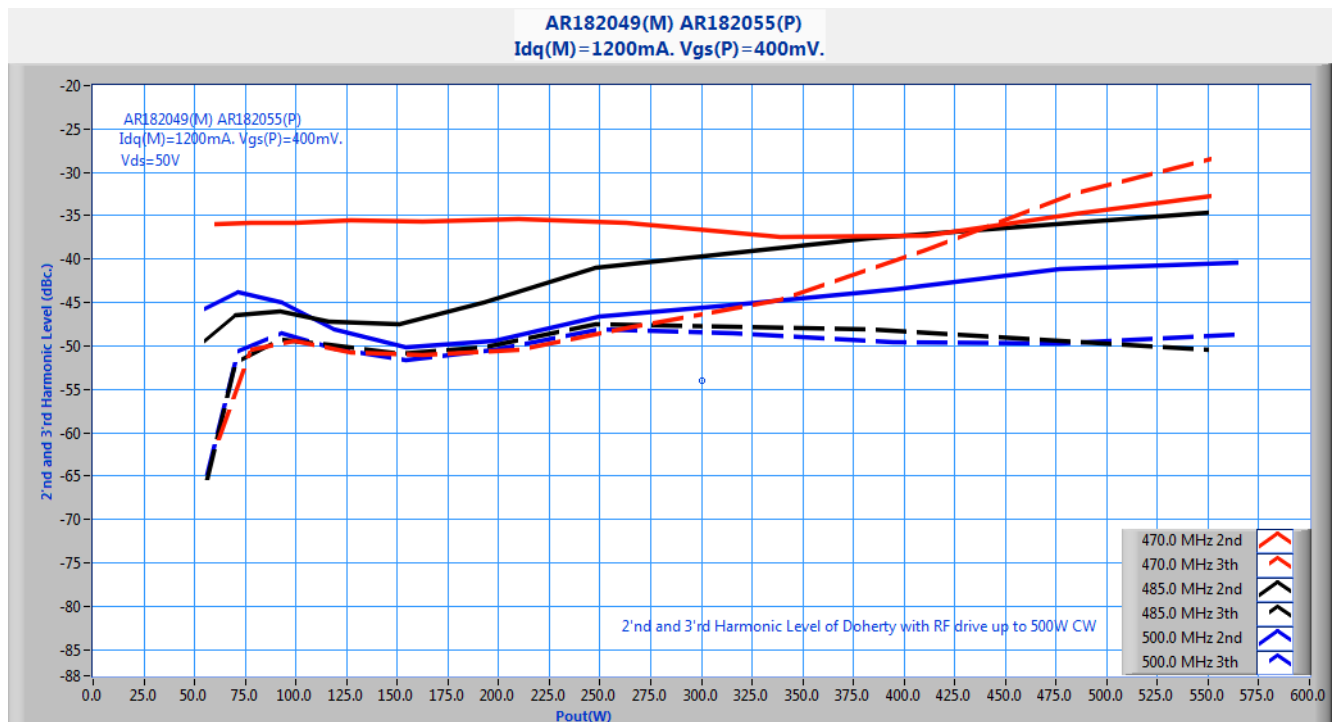
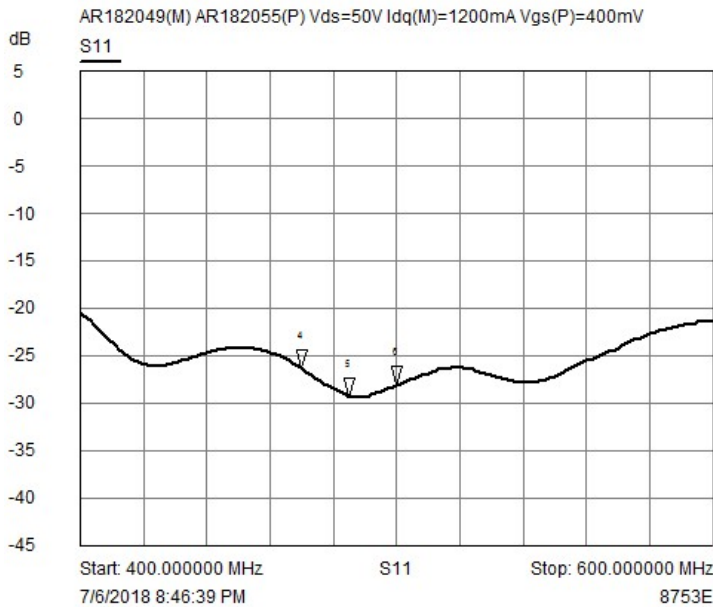

Figure 12. CW 2'nd and 3'rd Harmonic Level driven to 550 Watts

Figure 13. Small Signal S11 and S21 in Doherty mode



- 4 S11  
▽ 470.000000 MHz  
-26.3912 dB
- 5 S11  
▽ 485.000000 MHz  
-29.2593 dB
- 6 S11  
▽ 500.000000 MHz  
-28.1424 dB

S11 Vds=50V  
Idq. (Main)=1200mA.  
Vgs(Peak)=400mV.

2 X BLF989 Small Signal Doherty Mode

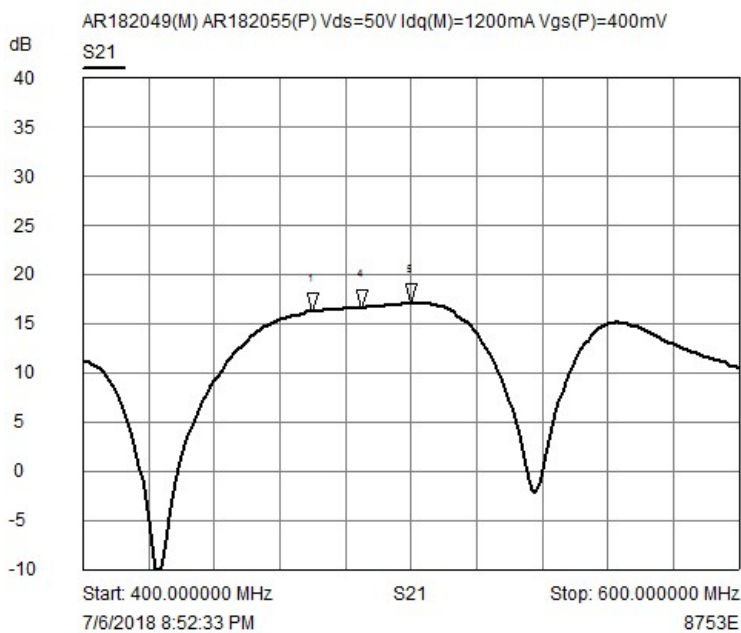

- 1 S21  
▽ 470.000000 MHz  
16.1785 dB
- 4 S21  
▽ 485.000000 MHz  
16.5652 dB
- 5 S21  
▽ 500.000000 MHz  
17.0020 dB

S21 Vds=50V  
Idq. (Main)=1200mA.  
Vgs(Peak)=400mV.

2 X BLF989 Small Signal Doherty Mode

## 10 BLF989 Doherty PCB Layouts

Figure 14. PCB Layout for Class AB Biasing (AR182049)

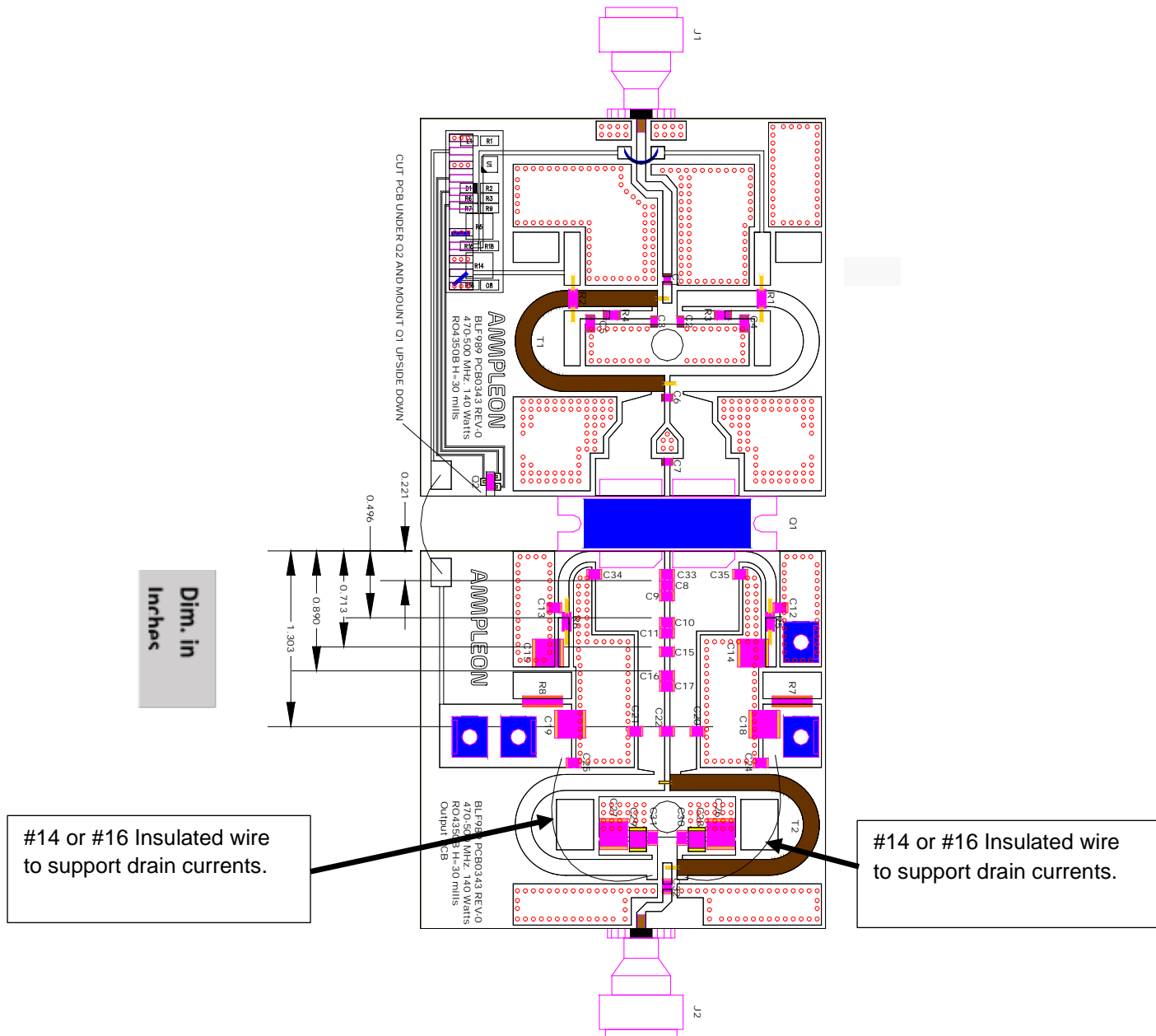

Figure 15. PCB Layout for Class C Biasing (AR182055)

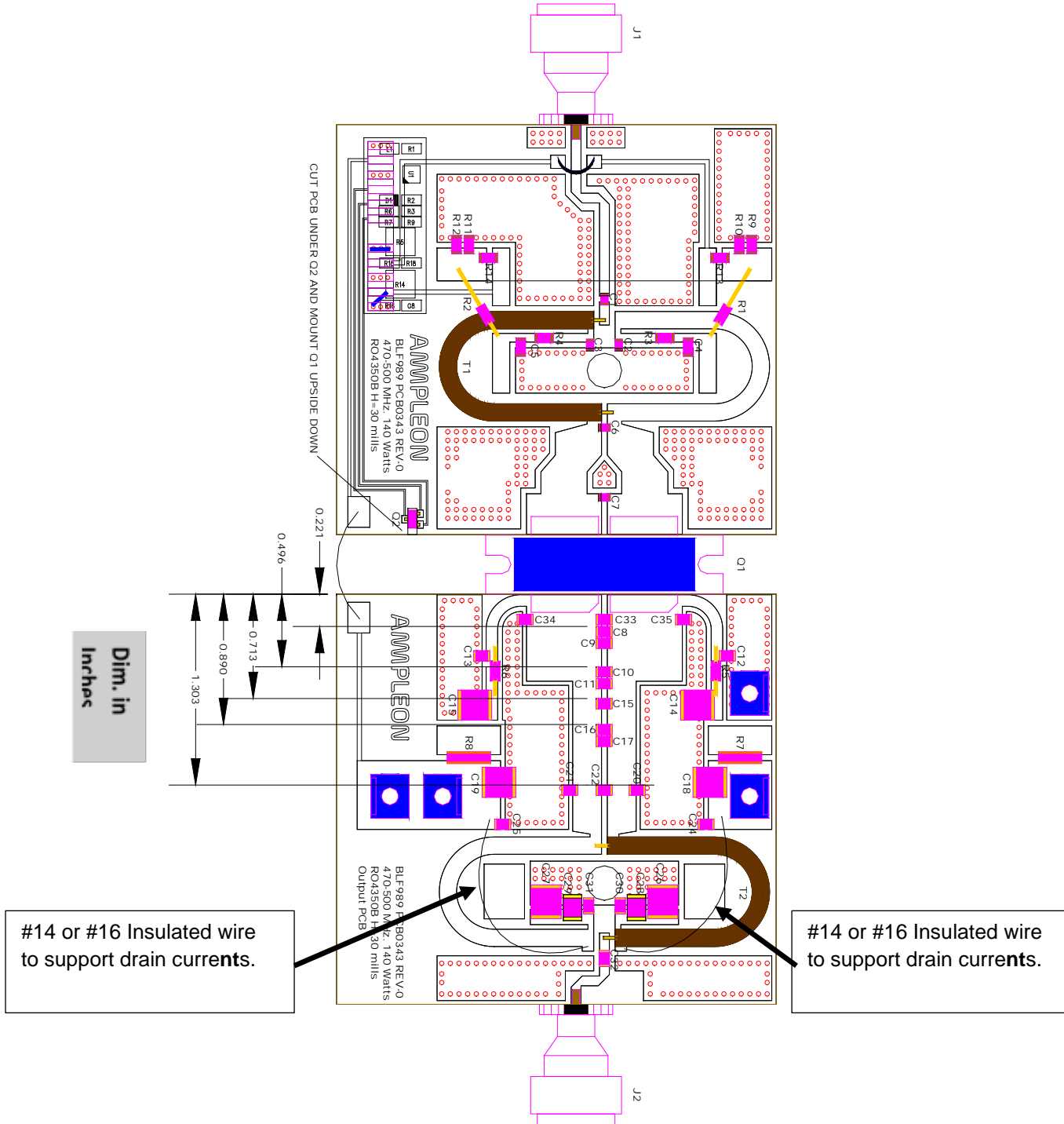
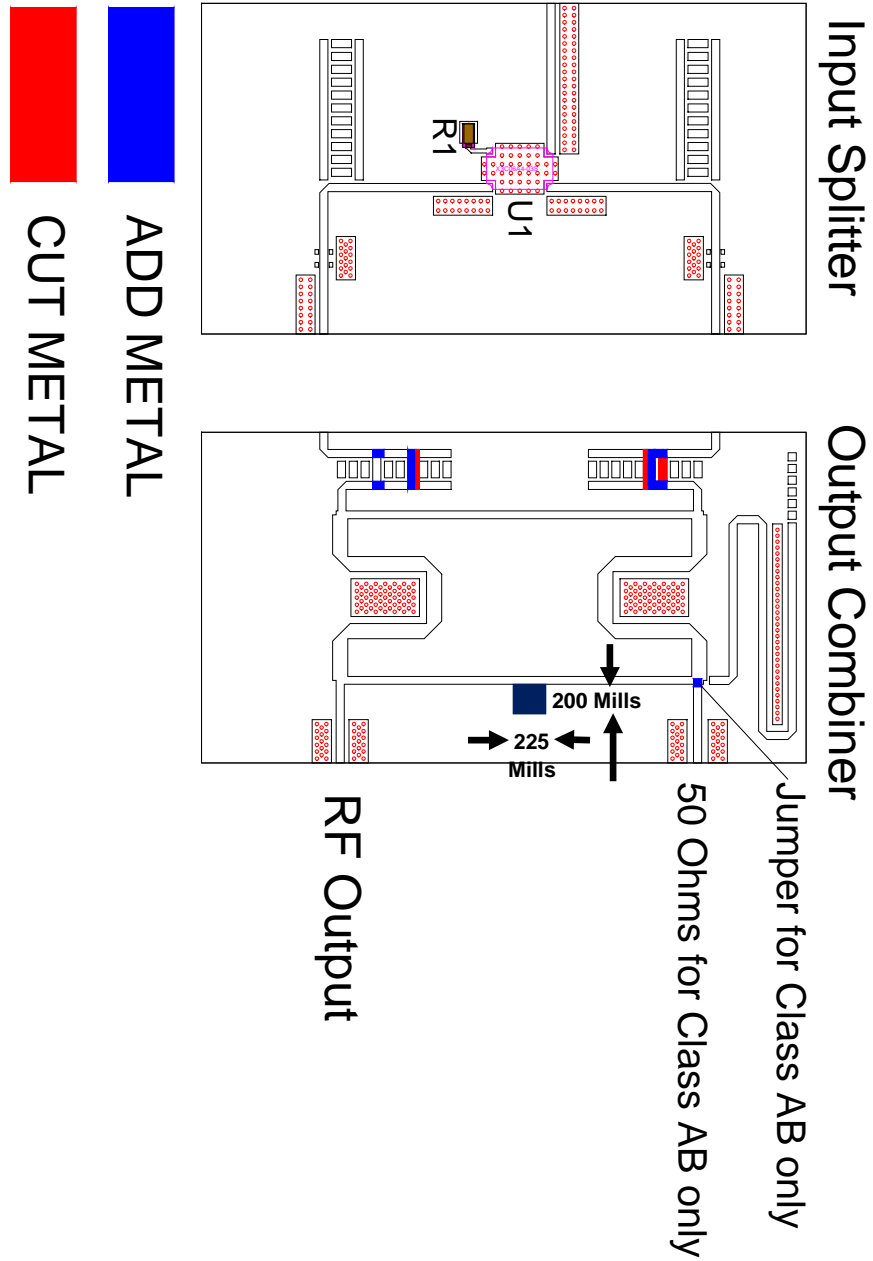

Figure 16. Input Splitter and Output Combiner



## 11 BLF989 Class AB and Doherty amplifier and Splitter/Combine BOM

Table 10. BLF989 Class AB and C Amplifier portion BOM

Designator	Description	Manufacturer	Part#
PCB Input PCB	Input PCB, 30 mil thk. RO4350B	Avanti Circuits	PCB0343 Rev.0
PCB Output PCB	Input PCB, 30 mil thk. RO4350B	Avanti Circuits	PCB0343 Rev.0
Input Base Plate	Input Brass Carrier 2.8" X 3"	Jones Machine	SMI0018 4350 Input
Output Base Plate	Output Brass Carrier 2.8" X 3"	Jones Machine	SMI0019 4350 Output
	Dual LDMOS Bias Board	Ampleon	
C1, C2, C3	100 pf. 0805 case (A2)	Passive Plus	0805N101JW251X
C4, C5	4.7 uF,50V SMT 1210 case	TDK	C3216X5R1H475M160AB
C6	12 pf. 0805 case (C1)	Passive Plus	0805N120JW251X
C7	18 pf. 0805 case (G1)	Passive Plus	0805N180JW251X
C8, C34, C35*Vert. Mount	12 pf. N1111 case	Passive Plus	1111N120JW501X
C9, C10, C11, C15, C16 *Vert. Mount	8.2 pf. N1111 case	Passive Plus	1111N8R2BW501X
C17*Vert. Mount	2.2 pf. N1111 case	Passive Plus	1111N2R2BW501X
C22*Vert. Mount	6.2 pf. N1111 case	Passive Plus	1111N6R2BW501X
C23*Vert. Mount	OMIT for 470-500 MHz		
C20, C21, C33 *Vert. Mount	10 pf. N1111 case	Passive Plus	1111N100JW501X
C12, C13, C24, C25, C30, C31, C32 *Vert. Mount	100 pf. N1111 case	Passive Plus	1111N101JW501X
C14, C15, C18, C19, C26, C27	4.7 uF, 100V SMT XR7 2220 case	TDK	C5750X7R2A475K230KA
C28, C29	0.01uf. 500V 1812 case	Vishay	VJ1812Y103KXEAT5Z
C36, C37	470MFD. 63V Tubular	Nichicon	Not on assy. Dwg. Solder in parallel with C30 and C31 on +50V line
Q1	LDMOS	Ampleon	BLF989
Q2 Mount Upside Down	2N2222 NPN transistor	Fairchild	MMBT2222
R1, R2	100-ohm wire wound axial	Ohmite	Order from Digii-Key
R3, R4	5.6-ohm 1206 case	Panasonic or equiv.	
R5, R6	10-ohm wire wound axial		Ordered from Mouser
R7, R8	0.005-ohm, 1% (3008 case)	Susumu	RL7520WT-R005-F
R9, R10, R11, R12	332-ohm 1206 case	Panasonic or equiv.	Class C Biasing
R13, R14	562-ohm 1206 case	Panasonic or equiv.	Class C Biasing

T1, T2	60mm. (2.36" long outer shield) 25-ohm Balun	E Z Form Cable	Semi Rigid Coax EZ 90-25 (copper jacket) or EZ 90-25-TP (tin plated copper jacket)
--------	--	----------------	--

Input and Output N connectors: Huber+Suhner Part #: 22641166 Type: 23 N-50-0-16

**Table 11. Input Splitter and Output Combiner BOM**

Designator	Description	Manufacturer	Part#
PCB Input PCB	Input PCB, 50 mil thk. RO3006	Avanti Circuits	PCB0347 Rev.0
PCB Output PCB	Output PCB, 50 mil thk. RO3006	Avanti Circuits	PCB0348 Rev.0
R1	50 Ohms 20W	EMC Technology Inc.	SMT2010TALN
U1	90 Degree Quad	Anaren	X3C060A4-035



## 12 Legal Information

### Definitions

**Draft** — The document is a draft version only. The content is still under internal review and subject to formal approval, which may result in modifications or additions. Ampleon does not give any representations or warranties as to the accuracy or completeness of information included herein and shall have no liability for the consequences of use of such information.

### Disclaimers

**Limited warranty and liability** — Information in this document is believed to be accurate and reliable. However, Ampleon does not give any representations or warranties, expressed or implied, as to the accuracy or completeness of such information and shall have no liability for the consequences of use of such information. Ampleon takes no responsibility for the content in this document if provided by an information source outside of Ampleon.

In no event shall Ampleon be liable for any indirect, incidental, punitive, special or consequential damages (including - without limitation - lost profits, lost savings, business interruption, costs related to the removal or replacement of any products or rework charges) whether or not such damages are based on tort (including negligence), warranty, breach of contract or any other legal theory.

Notwithstanding any damages that customer might incur for any reason whatsoever, Ampleon' aggregate and cumulative liability towards customer for the products described herein shall be limited in accordance with the Terms and conditions of commercial sale of Ampleon.

**Right to make changes** — Ampleon reserves the right to make changes to information published in this document, including without limitation specifications and product descriptions, at any time and without notice. This document supersedes and replaces all information supplied prior to the publication hereof.

**Suitability for use** — Ampleon products are not designed, authorized or warranted to be suitable for use in life support, life-critical or safety-critical systems or equipment, nor in applications where failure or malfunction of an Ampleon product can reasonably be expected to result in personal injury, death or severe property or environmental damage. Ampleon and its suppliers accept no liability for inclusion and/or use of Ampleon products in such equipment or applications and therefore such inclusion and/or use is at the customer's own risk.

**Applications** — Applications that are described herein for any of these products are for illustrative purposes only. Ampleon makes no representation or warranty that such applications will be suitable for the specified use without further testing or modification.

Customers are responsible for the design and operation of their applications and products using Ampleon products, and Ampleon accepts no liability for any assistance with applications or customer product design. It is customer's sole responsibility to determine whether the Ampleon product is suitable and fit for the customer's applications and products planned, as well as for the planned application and use of customer's third party customer(s). Customers should provide appropriate design and operating safeguards to minimize the risks associated with their applications and products.

Ampleon does not accept any liability related to any default, damage, costs or problem which is based on any weakness or default in the customer's applications or products, or the application or use by customer's third party customer(s). Customer is responsible for doing all necessary testing for the customer's applications and products using Ampleon products in order to avoid a default of the applications and the products or of the application or use by customer's third party customer(s). Ampleon does not accept any liability in this respect.

**Export control** — This document as well as the item(s) described herein may be subject to export control regulations. Export might require a prior authorization from competent authorities.

### Trademarks

Notice: All referenced brands, product names, service names and trademarks are the property of their respective owners.

Any reference or use of any 'NXP' trademark in this document or in or on the surface of Ampleon products does not result in any claim, liability or entitlement vis-à-vis the owner of this trademark. Ampleon is no longer part of the NXP group of companies and any reference to or use of the 'NXP' trademarks will be replaced by reference to or use of Ampleon's own trademarks.

### 12.1 Contact information

For more information, please visit: <http://www.ampleon.com>

For sales office addresses, please visit: <http://www.ampleon.com/sales>