

Document information

| Info | Content |
|-----------------|---|
| Keywords | ART2K0PE, 352 MHz, Coplanar balun, 65 V LDMOS |
| Abstract | This application report describes the design and performance of a 1600 W 352 MHz CW power amplifier using the LDMOS ART2K0PE power transistor and PCB integrated coplanar baluns. |

Revision history

| Rev | Date | Description |
|-----|----------|-----------------|
| 1 | 20201009 | Initial version |
| | | |

Contact information

For more information, please visit: <http://www.ampleon.com>

For sales office addresses, please visit: <http://www.ampleon.com/sales>

1. Introduction

This application report describes the results of an ART2K0PE demo board at 352 MHz producing 1600 watt CW with an efficiency of more than 74 %.

This amplifier design can be used in synchrotron particle accelerators but can also be used for other applications at this frequency.

The demo board has been tested at VDD = 50 V, 60 V and 65 V, with a quiescent drain current (IDq) of 100 mA, 200 mA and 500 mA for the total device. Gain and efficiency were measured CW at 352 MHz. IDq is adjusted by connecting a voltage supply to the respective connections on the input circuit. The procedure to adjust the IDq is to start with a low voltage of approximately 0.5 V and increase the voltage slowly until the IDq reaches the wanted value. The gate bias voltage (VGG) value needed is approximately 1.73 V for 100 mA, 1.93 V for 200 mA and 2.01 V for 500 mA.

Results of the measurements are shown in section 2.2.

A picture of the amplifier is shown below in figure 1. The size of the demo board is 80 mm x 150 mm, excluding the N-connectors.

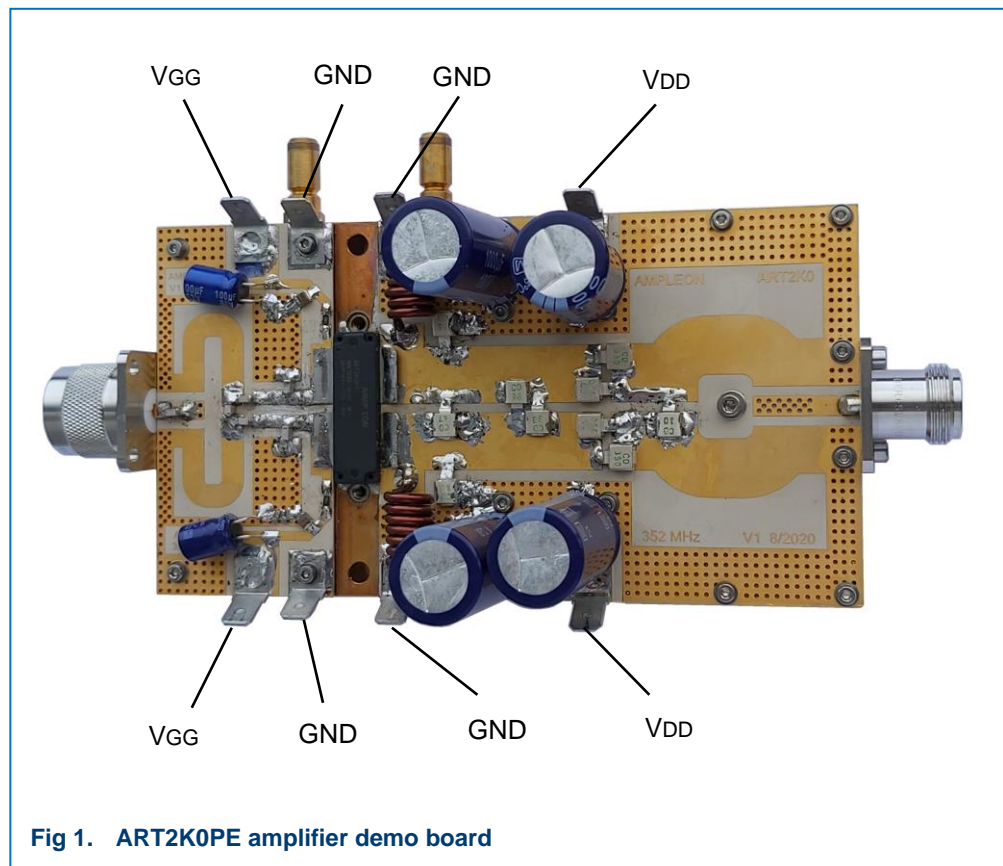

Fig 1. ART2K0PE amplifier demo board

2. Test circuit

The test circuit has the following features:

- 352 MHz operating frequency
- 1600 W power output at 74 % efficiency
- RF and thermally stable
- Demo board size 80 mm x 150 mm
- Coplanar balun at the input and output circuit
- Water cooled

2.1 Schematic diagram

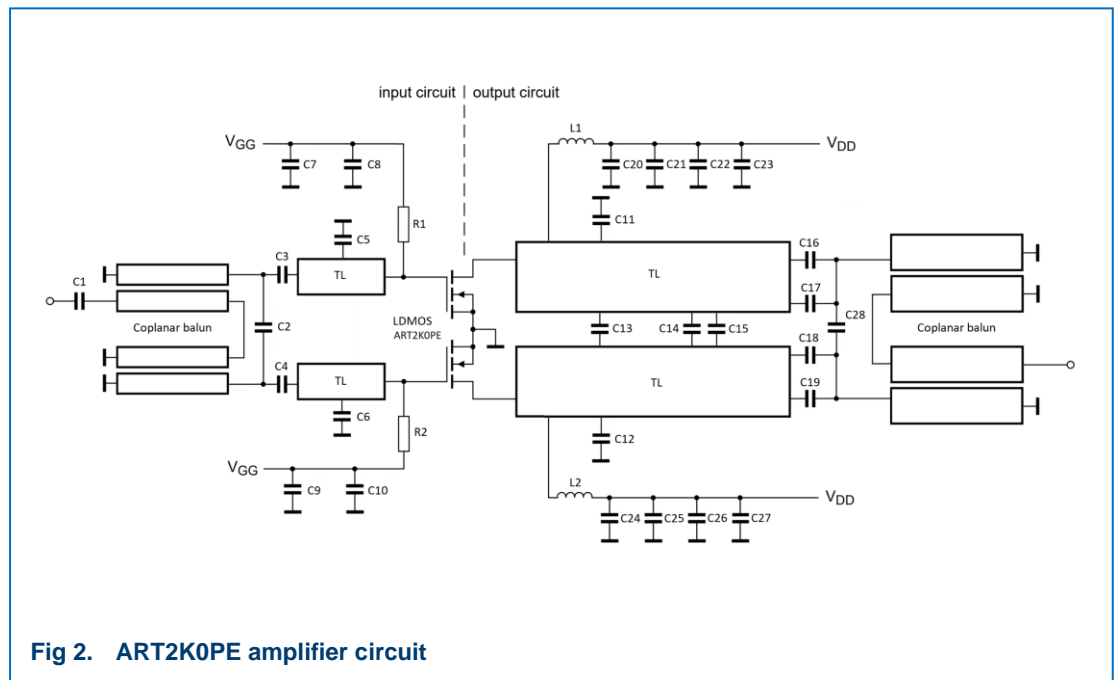

The demo board was built with double sided RT/duroid 6035HTC substrate material with $\epsilon_r = 3.5$. The substrate material has a height of 0.762 mm and the final copper thickness is 70 μm . Both input and output circuit use the same substrate material.

Cooling is provided by connecting a 25 °C water supply to the baseplate cooling tubes.

Both input and output circuit make use of a coplanar balun that are more production friendly because it omits the use of thick coaxial balun cables that are difficult to handle and give assembly variations. The coplanar balun is designed to have the balanced side on the top metal layer, while the single ended side is using the bottom metal layer. To reduce the baseplate ground effect on the single ended side, a 5 mm deep cavity is present underneath the baluns inside the baseplate.

At the input circuit the power levels are low enough that no excess heating occurs, and an air cavity is sufficient for the input balun. The output balun must handle high power levels and extra cooling is required to avoid overheating. To give extra cooling to the output balun the output cavity is filled with *Thermipad TP22626* thermal Gap filler material. The output balun is designed according to the ϵ_r of the Thermipad material. In the middle of the balun cavity a small pedestal is available on which the coplanar balun can be pulled down with a small screw this to make sure the coplanar balun makes tight contact with the Thermal Gap filler material.

To reduce losses and heat generation in the output circuit high quality Cornell Dubilier mica capacitors need to be used.

The circuit can be slightly tuned for different combinations of maximum output power and efficiency by varying the value and position of C11, C12 and C13 in the output circuit.

At the input circuit the S11 and amplifier gain can be optimized by changing the value and position of capacitors C5 and C6. The distance to the transistor should be the same for both capacitors C5 and C6.

2.2 Measurement data

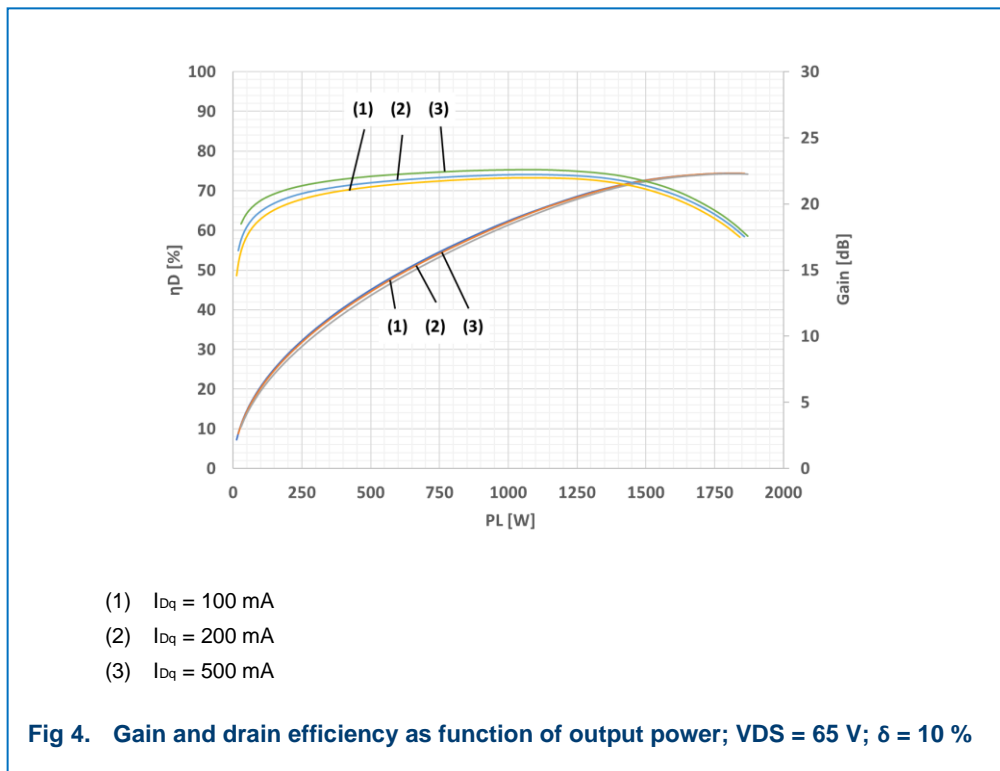
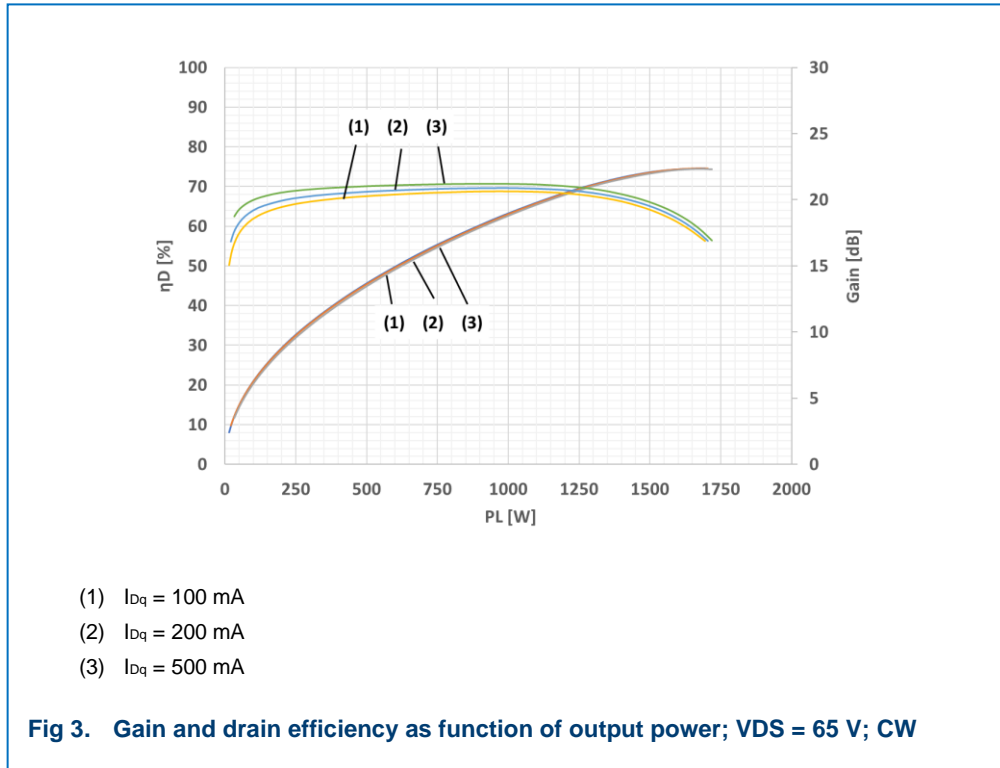

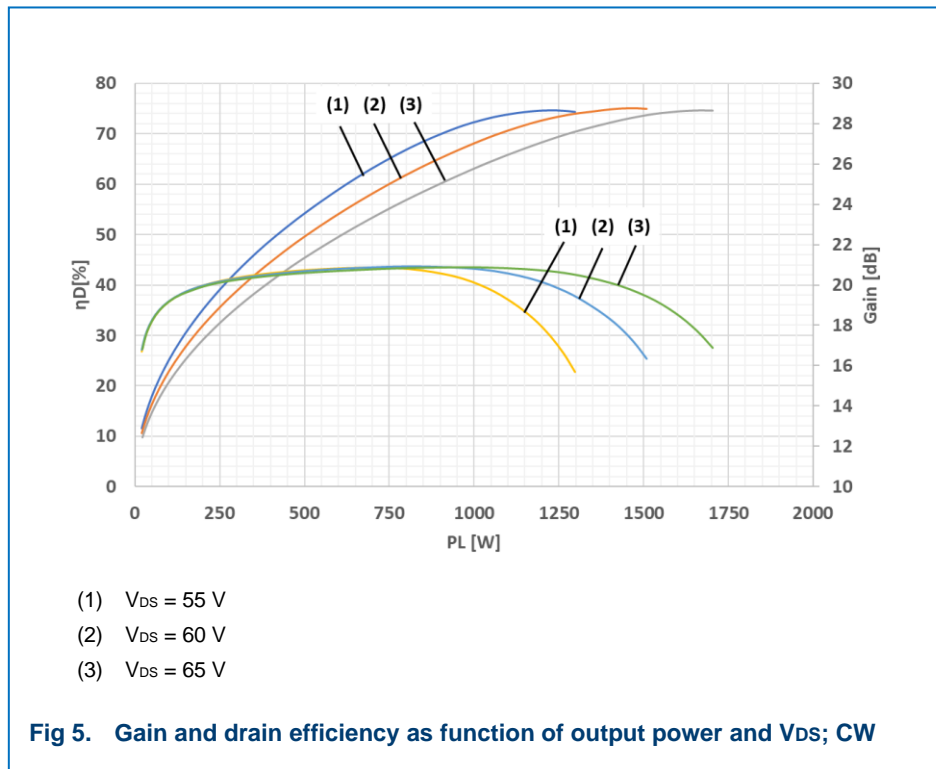

2.3 Thermal behavior of the output circuit

The highest temperature measured at 1650 W CW is 131 °C at the top of the ART2K0PE transistor package.

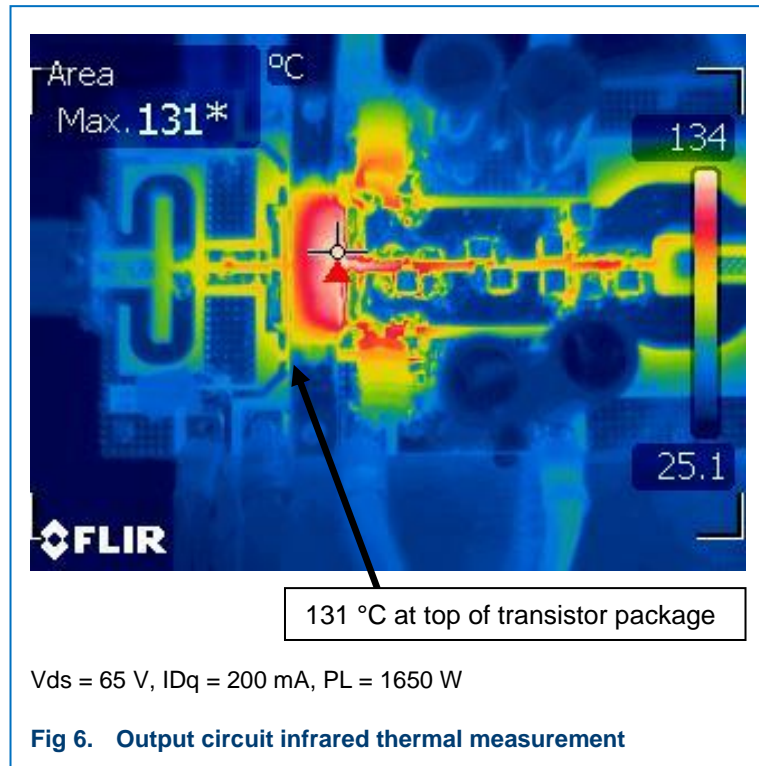

The junction temperature of the LDMOS die was estimated from infrared thermal test data that is available and shown in figure 6. It is estimated by calculation that the power dissipation (P_{diss}) is approximately 562 W (at $PL = 1650$ W and $\eta_D = 74.6$ %). When the device is well soldered to the heatsink the total R_{th} from die to heatsink will be around 0.12K/W. This will give a die temperature of 93 °C when the cooling water temperature is 25 °C.

2.4 Layout and components
2.4.1 Output circuit

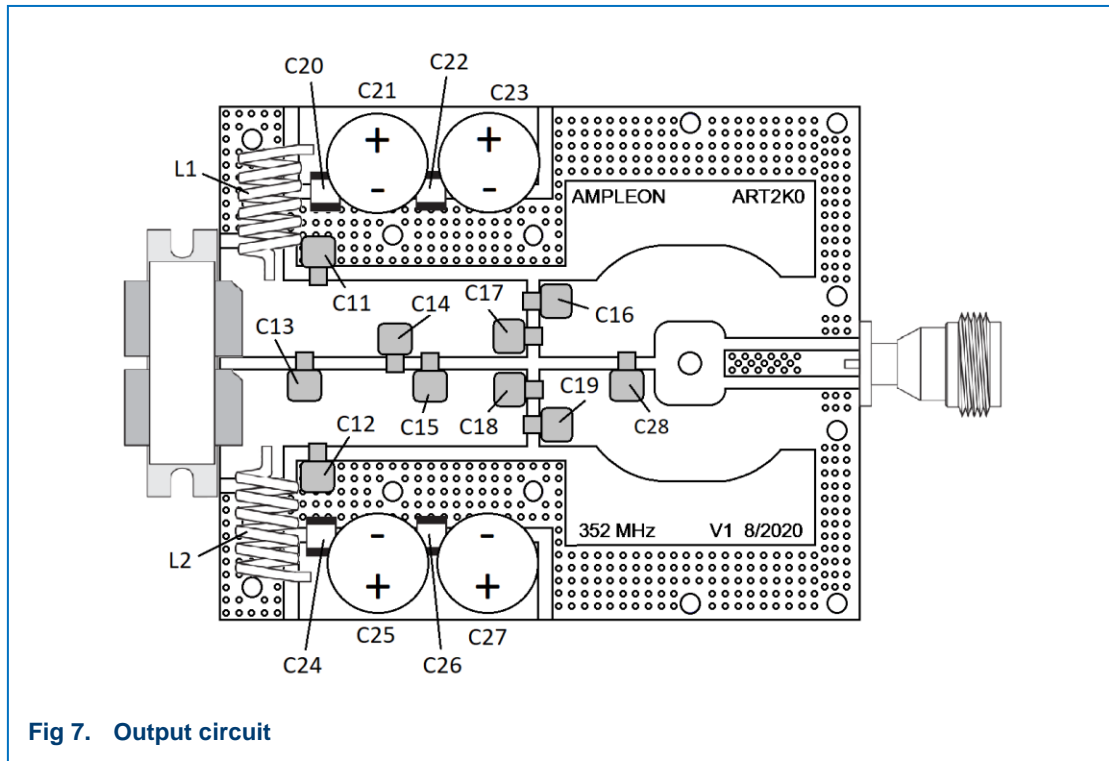

Fig 7. Output circuit

For demo purposes the output circuit makes use of a female N-connector for easy handling. It is however highly recommended to use a connector type that can handle higher power levels in a final application, like a 7/16 type connector.

Table 1. Output circuit bill of materials

| Circuit reference | Description | Type / manufacturer |
|----------------------|--|------------------------|
| PCB | RT/duroid 6035HTC, 0.762 mm height, 70 µm CU thickness | Rogers |
| L1, L2 | 6 turns, 2.0 mm wire, 6 mm diameter, close wound | Enamel copper wire |
| C11, C12 | 91 pF | Cornell Dubilier MCM01 |
| C13 | 47 pF | Cornell Dubilier MCM01 |
| C14 | 36 pF | Cornell Dubilier MCM01 |
| C15 | 33 pF | Cornell Dubilier MCM01 |
| C16, C17, C18, C19 | 350 pF | Cornell Dubilier MCM01 |
| C28 | 10 pF | Cornell Dubilier MCM01 |
| C20, C24 | 1 nF | ATC800B |
| C21, C23, C25 C27 | 1000 µF / 100 V | Electrolytic |
| C22, C26 | 10 µF / 100 V | X7R ceramic |
| N connector | Female, 50 Ω | Suhner |
| LDMOS | ART2K0PE | Ampleon |

2.4.2 Input circuit

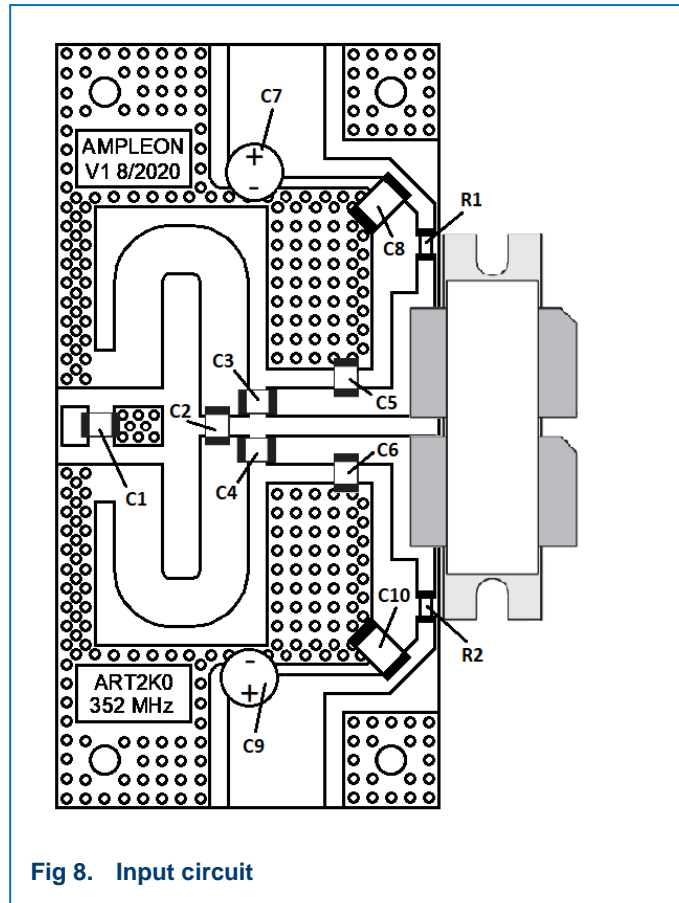

Fig 8. Input circuit

Table 2. Input circuit bill off materials

| Circuit reference | Description | Type / manufacturer |
|-------------------|---|---------------------|
| PCB | RT/duroid 6035HTC, 0.762 mm height, 70 μ m CU thickness | Rogers |
| R1, R2 | 47 Ω | 1206 SMD |
| C1 | 110 pF | ATC800B |
| C2 | 18 pF | ATC800B |
| C3, C4 | 33 pF | ATC800B |
| C5, C6 | 82 pF | ATC800B |
| C7, C9 | 47 μ F / 63V | Electrolytic |
| C8, C10 | 1 nF | ATC800B |
| N connector | Male, 50 Ω | Suhner |

3. Abbreviations

Table 3. Abbreviations

| Acronym | Description |
|---------|--|
| CW | Continuous Wave |
| LDMOS | Laterally Diffused Metal-Oxide Semiconductor |
| PCB | Printed-Circuit Board |
| | |
| | |
| | |
| | |
| | |

4. Legal information

4.1 Definitions

Draft — The document is a draft version only. The content is still under internal review and subject to formal approval, which may result in modifications or additions. Ampleon does not give any representations or warranties as to the accuracy or completeness of information included herein and shall have no liability for the consequences of use of such information.

4.2 Disclaimers

Limited warranty and liability — Information in this document is believed to be accurate and reliable. However, Ampleon does not give any representations or warranties, expressed or implied, as to the accuracy or completeness of such information and shall have no liability for the consequences of use of such information. Ampleon takes no responsibility for the content in this document if provided by an information source outside of Ampleon.

In no event shall Ampleon be liable for any indirect, incidental, punitive, special or consequential damages (including - without limitation - lost profits, lost savings, business interruption, costs related to the removal or replacement of any products or rework charges) whether or not such damages are based on tort (including negligence), warranty, breach of contract or any other legal theory.

Notwithstanding any damages that customer might incur for any reason whatsoever, Ampleon' aggregate and cumulative liability towards customer for the products described herein shall be limited in accordance with the *Terms and conditions of commercial sale* of Ampleon.

Right to make changes — Ampleon reserves the right to make changes to information published in this document, including without limitation specifications and product descriptions, at any time and without notice. This document supersedes and replaces all information supplied prior to the publication hereof.

Suitability for use — Ampleon products are not designed, authorized or warranted to be suitable for use in life support, life-critical or safety-critical systems or equipment, nor in applications where failure or malfunction of an Ampleon product can reasonably be expected to result in personal injury, death or severe property or environmental damage. Ampleon and its suppliers accept no liability for inclusion and/or use of Ampleon products in such equipment or applications and therefore such inclusion and/or use is at the customer's own risk.

Applications — Applications that are described herein for any of these products are for illustrative purposes only. Ampleon makes no representation

or warranty that such applications will be suitable for the specified use without further testing or modification.

Customers are responsible for the design and operation of their applications and products using Ampleon products, and Ampleon accepts no liability for any assistance with applications or customer product design. It is customer's sole responsibility to determine whether the Ampleon product is suitable and fit for the customer's applications and products planned, as well as for the planned application and use of customer's third party customer(s). Customers should provide appropriate design and operating safeguards to minimize the risks associated with their applications and products.

Ampleon does not accept any liability related to any default, damage, costs or problem which is based on any weakness or default in the customer's applications or products, or the application or use by customer's third party customer(s). Customer is responsible for doing all necessary testing for the customer's applications and products using Ampleon products in order to avoid a default of the applications and the products or of the application or use by customer's third party customer(s). Ampleon does not accept any liability in this respect.

Export control — This document as well as the item(s) described herein may be subject to export control regulations. Export might require a prior authorization from competent authorities.

Translations — A non-English (translated) version of a document is for reference only. The English version shall prevail in case of any discrepancy between the translated and English versions.

Terms and conditions of commercial sale — Ampleon products are sold subject to the general terms and conditions of commercial sale, as published at <http://www.ampleon.com/terms>, unless otherwise agreed in a valid written individual agreement. In case an individual agreement is concluded only the terms and conditions of the respective agreement shall apply. Ampleon hereby expressly objects to applying the customer's general terms and conditions with regard to the purchase of Ampleon products by customer.

4.3 Trademarks

Notice: All referenced brands, product names, service names and trademarks are property of their respective owners.

Any reference or use of any 'NXP' trademark in this document or in or on the surface of Ampleon products does not result in any claim, liability or entitlement vis-à-vis the owner of this trademark. Ampleon is no longer part of the NXP group of companies and any reference to or use of the 'NXP' trademarks will be replaced by reference to or use of Ampleon's own trademarks.

5. Contents

| | | |
|-----------|--|-----------|
| 1. | Introduction..... | 3 |
| 2. | Test circuit | 4 |
| 2.1 | Schematic diagram..... | 4 |
| 2.2 | Measurement data..... | 6 |
| 2.3 | Thermal behavior of the output circuit | 8 |
| 2.4 | Layout and components | 9 |
| 2.4.1 | Output circuit | 9 |
| 2.4.2 | Input circuit | 10 |
| 3. | Abbreviations..... | 11 |
| 4. | Legal information..... | 12 |
| 4.1 | Definitions..... | 12 |
| 4.2 | Disclaimers | 12 |
| 4.3 | Trademarks | 12 |
| 5. | Contents | 13 |
| 6. | List of figures | 13 |
| 7. | List of tables | 14 |

6. List of figures

- Fig 1. ART2K0PE amplifier demo board
- Fig 2. ART2K0PE amplifier circuit
- Fig 3. Gain and drain efficiency as function of output power; $V_{DS} = 65 \text{ V}$; CW
- Fig 4. Gain and drain efficiency as function of output power; $V_{DS} = 65 \text{ V}$; $\delta = 10 \%$
- Fig 5. Gain and drain efficiency as function of output power and V_{DS} ; CW
- Fig 6. Output circuit infrared thermal measurement
- Fig 7. Output circuit
- Fig 8. Input circuit

Please be aware that important notices concerning this document and the product(s) described herein, have been included in the section 'Legal information'.

7. List of tables

Table 1. Output circuit bill of materials

Table 2. Input circuit bill off materials

Table 3. Abbreviations

Please be aware that important notices concerning this document and the product(s) described herein, have been included in the section 'Legal information'.

© Ampleon Netherlands B.V. 2020.

All rights reserved.

For more information, visit: <http://www.ampleon.com>

For sales office addresses, please visit: <http://www.ampleon.com/sales>

Date of release: 9 September 2020

Document identifier: AR201203